

Instruction Manual
Compact Inverter

IMO Jaguar CUB

CAUTION

Thank you for purchasing our Jaguar CUB series of inverters.

- This product is designed to drive a three-phase induction motor. Read through this instruction manual and be familiar with the handling procedure for correct use.
- Improper handling blocks correct operation or causes a short life or failure.
- Deliver this manual to the end user of the product. Keep this manual in a safe place until the inverter is discarded.
- For the usage of optional equipment, refer to the manuals prepared for optional equipment.

IMO Precision Controls Ltd

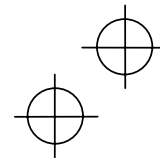
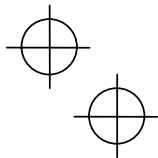

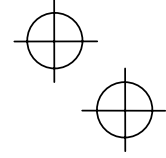
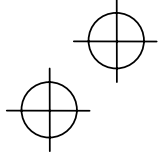

Copyright © 2003. IMO Precision Controls Ltd

All rights reserved.

No part of this publication may be reproduced or copied without prior written permission from IMO Precision Controls Ltd

All products and company names mentioned in this manual are trademarks or registered trademarks of their respective holders.

The information contained herein is subject to change without prior notice for improvement.

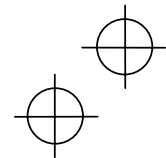
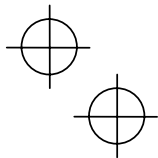

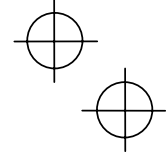
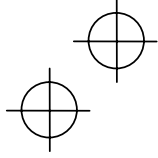

Preface

Thank you for purchasing our Jaguar CUB series of inverters.

This product is designed to drive a three-phase induction motor. Read through this instruction manual and be familiar with the handling method for correct use.

Improper handling blocks correct operation or causes a short life or failure.

Have this manual delivered to the end user of the product. Keep this manual in a safe place until the inverter is discarded.

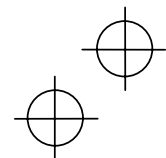
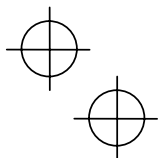

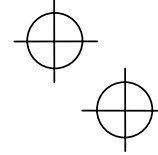
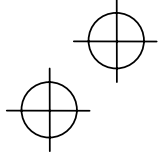



■ Safety precautions

Read this manual thoroughly before proceeding with installation, connections (wiring), operation, or maintenance and inspection. Ensure you have sound knowledge of the device and familiarize yourself with all safety information and precautions before proceeding to operate the inverter.

Safety precautions are classified into the following two categories in this manual.

 WARNING	Failure to heed the information indicated by this symbol may lead to dangerous conditions, possibly resulting in death or serious bodily injuries.
 CAUTION	Failure to heed the information indicated by this symbol may lead to dangerous conditions, possibly resulting in minor or light bodily injuries and/or substantial property damage.

Failure to heed the information contained under the CAUTION title can also result in serious consequences. These safety precautions are of utmost importance and must be observed at all times.

Application

 WARNING
<ul style="list-style-type: none">• Jaguar CUB is designed to drive a three-phase induction motor. Do not use it for single-phase motors or for other purposes. Fire or an accident could occur.• Jaguar CUB may not be used for a life-support system or other purposes directly related to the human safety.• Though Jaguar CUB is manufactured under strict quality control, install safety devices for applications where serious accidents or material losses are foreseen in relation to the failure of it. An accident could occur.

Installation

 WARNING
<ul style="list-style-type: none">• Install the inverter on a nonflammable material such as metal. Otherwise fire could occur.• Do not place flammable matter nearby. Doing so could cause fire.

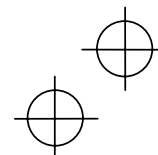
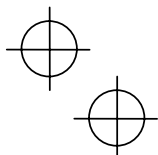

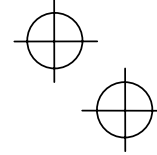
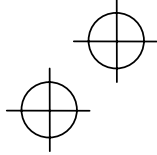

CAUTION

- Do not support the inverter by its terminal block cover during transportation.
Doing so could cause a drop of the inverter and cause injuries.
- Prevent lint, paper fibers, sawdust, dust, metallic chips, or other foreign materials from getting into the inverter or from accumulating on the heat sink.
Doing so could cause fire or an accident.
- Do not install or operate an inverter that is damaged or lacking parts.
Doing so could cause fire, an accident or injuries.
- Do not stand a shipping box.
- Do not stack shipping boxes higher than the indicated information printed on those boxes.
Doing so could cause injuries.

Wiring

WARNING

- When wiring the inverter to the power source, insert a recommended molded case circuit breaker (MCCB) or residual-current-operated protective device (RCD)/earth leakage circuit breaker (ELCB) (with the exception of those exclusively designed for protection from ground faults) in the path of power lines. Use the devices within the related current range.
- Use wires in the specified size.
Otherwise, fire could occur.
- Do not use one multicore cable in order to connect several inverters with motors.
- Do not connect a surge killer to the inverter's secondary circuit.
Doing so could cause fire.
- Be sure to connect the grounding wires without fail.
Otherwise, electric shock or fire could occur.
- Qualified electricians should carry out wiring.
- Be sure to perform wiring after turning the power off.
- Ground the inverter according to the requirements of your national and local safety regulations.
Otherwise, electric shock could occur.
- Be sure to perform wiring after installing the inverter body.
Otherwise, electric shock or injuries could occur.
- Check that the number of input phases and the rated voltage of the product match the number of phases and the voltage of the AC power supply to which the product is to be connected.
Otherwise fire or an accident could occur.
- Do not connect the power source wires to output terminals (U, V, and W).
- Do not insert a braking resistor between terminals P (+) and N (-), P1 and N (-), P (+) and P1, DB and N (-), or P1 and DB.
Doing so could cause fire or an accident.

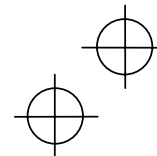
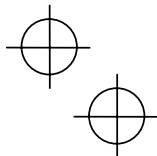

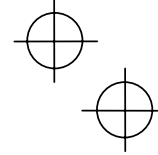
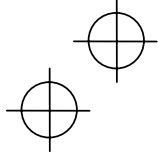

CAUTION

- Wire the three-phase motor to terminals U, V, and W of the inverter, aligning phases each other.
Otherwise injuries could occur.
- The inverter, motor and wiring generate electric noise. Take care of malfunction of the nearby sensors and devices. To prevent the motor from malfunctioning, implement noise control measures.
Otherwise an accident could occur.

Operation

WARNING

- Be sure to install the terminal block cover before turning the power on. Do not remove the cover during power application.
Otherwise electric shock could occur.
- Do not operate switches with wet hands.
Doing so could cause electric shock.
- If the retry function has been selected, the inverter may automatically restart and drive the motor according to some causes after tripping.
(Design the machinery or equipment so that human safety is ensured after restarting.)
- If the stall prevention function has been selected, the inverter may operate at an acceleration/deceleration time or frequency different from the set ones. Design the machine so that safety is ensured even in such cases.
Otherwise an accident could occur.
- The STOP key is only effective when function setting (Function code F02) has been established to enable the STOP key. Prepare an emergency stop switch separately. If you disable the STOP key priority function and enable command (FWD) or (REV), you cannot stop the inverter output by the STOP key on the built-in keypad.
- If an alarm reset is made with the operation signal turned on, a sudden start will occur. Check that the operation signal is turned off in advance.
Otherwise an accident could occur.
- If you enable the "restart mode after instantaneous power failure" (Function code F14 = 4 or 5), then the inverter automatically restarts running the motor when the power is recovered.
(Design the machinery or equipment so that human safety is ensured after restarting.)
- If you set the function codes wrongly or without completely understanding this instruction manual and the Jaguar CUB User's Manual, the motor may rotate with a torque or at a speed not permitted for the machine.
An accident or injuries could occur.
- Do not touch the inverter terminals while the power is applied to the inverter even if the inverter stops.
Doing so could cause electric shock.

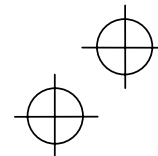
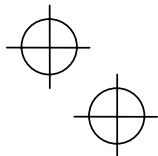

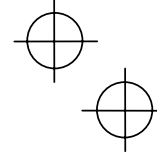
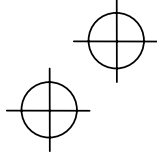

CAUTION

- Do not turn the main circuit power on or off in order to start or stop inverter operation.
Doing so could cause failure.
- Do not touch the heat sink or braking resistor because they become very hot.
Doing so could cause burns.
- Setting the inverter to high speeds is easy. Check the specifications of the motor and machinery before changing the setting.
- The brake function of the inverter does not provide mechanical holding means.
Injuries could occur.

Maintenance and inspection, and parts replacement

WARNING

- Turn the power off and wait for at least five minutes before starting inspection. Further, check that the LED monitor is unlit, and check the DC link circuit voltage across the P (+) and N (-) terminals to be lower than 25 VDC.
Otherwise, electric shock could occur.
- Maintenance, inspection, and parts replacement should be made only by qualified persons.
- Take off the watch, rings and other metallic matter before starting work.
- Use insulated tools.
Otherwise, electric shock or injuries could occur.

Disposal

CAUTION

- Handle the inverter as an industrial waste when disposing of it.
Otherwise injuries could occur.

Others

WARNING

- Never attempt to modify the inverter.
Doing so could cause electric shock or injuries.

GENERAL PRECAUTIONS

Drawings in this manual may be illustrated without covers or safety shields for explanation of detail parts. Restore the covers and shields in the original state and observe the description in the manual before starting operation.

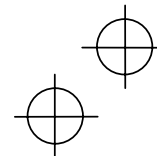
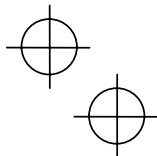

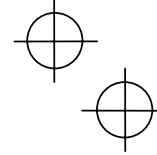
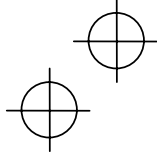

Conformity to the Low Voltage Directive in the EU

If installed according to the guidelines given below, inverters marked with CE or TÜV are considered as compliant with the Low Voltage Directive 73/23/EEC.

CAUTION

1. The ground terminal  should always be connected to the ground. Do not use only a residual-current-operated protective device (RCD)/earth leakage circuit breaker (ELCB)* as the sole method of electric shock protection. Be sure to use ground wires whose size is greater than power supply lines.
*With the exception of those exclusively designed for protection from ground faults.
2. When used with the inverter, a molded case circuit breaker (MCCB), residual-current-operated protective device (RCD)/earth leakage circuit breaker (ELCB) or magnetic contactor (MC) should conform to the EN or IEC standards.
3. When you use a residual-current-operated protective device (RCD)/earth leakage circuit breaker (ELCB) for protection from electric shock in direct or indirect contact power lines or nodes, be sure to use **type B of RCD/ELCB** at the power supply side of the electric equipment for three-phase 200/400 V power supplies. For single-phase 200 V power supplies, use **type A**.
When you use no RCD/ELCB, take any other protective measure that isolates the electric equipment from other equipment on the same power supply line using double or reinforced insulation or that isolates the power supply lines connected to the electric equipment using an isolation transformer.
4. The inverter should be used in an environment that does not exceed Pollution Degree 2 requirements. If the environment conforms to Pollution Degree 3 or 4, install the inverter in an enclosure of IP54 or higher.
5. Install the inverter, AC or DC reactor, input or output filter in an enclosure with minimum degree of protection of IP2X (Top surface of enclosure shall be minimum IP4X when it can be easily accessed), to prevent human body from touching directly to live parts of these equipment.
6. To make an inverter with no integrated EMC filter conform to the EMC directive, it is necessary to connect an external EMC filter to the inverter and install them properly so that the entire equipment including the inverter conforms to the EMC directive.
7. Do not connect any copper wire directly to grounding terminals. Use crimp terminals with tin or equivalent plating to connect them.
8. To connect the three-phase or single-phase 200 V series of inverters to the power supply in Overvoltage Category III or to connect the 3-phase 400 V series of inverters to the power supply in Overvoltage Category II or III, a supplementary insulation is required for the control circuitry.
9. When you use an inverter at an altitude of more than 2000 m, you should apply basic insulation for the control circuits of the inverter. The inverter cannot be used at altitudes of more than 3000 m.
10. The power supply mains neutral has to be earthed for the three-phase 400 V class inverter.

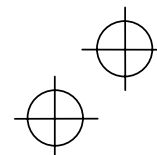
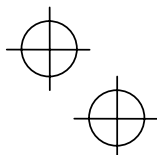

Conformity to the Low Voltage Directive in the EU (Continued)

⚠ CAUTION

11. Use wires listed in EN60204 Appendix C.

Power supply voltage	Applicable motor rating (kW)	Inverter type	Rated current (A) ^{*1} of MCCB or RCD/ELCB		Recommended wire size (mm ²) ^{*2}					
					Main circuit power input [L1/R, L2/S, L3/T] [L1/L, L2/N] Grounding 		Inverter output [U, V, W]	DCR [P1, P (+)] Braking resistor [P (+), DB]	Control circuit (30A, 30B, 30C)	
			w/ DCR	w/o DCR ^{*3}	w/ DCR	w/o DCR				
Three-phase 200 V	0.4	CUB3A-2□	6	6	2.5	2.5	2.5	2.5	0.5	
	0.75	CUB5A-2□		10						
	1.5	CUB8A-2□	10	16						
	2.2	CUB11A-2□		20						
	3.7	CUB17A-2□	20	35						4
Three-phase 400 V	0.4	CUB1A5-4□	6	6	2.5	2.5	2.5	2.5	0.5	
	0.75	CUB2A5-4□		10						
	1.5	CUB3A7-4□	10	16						
	2.2	CUB5A5-4□		20						
	4.0	CUB9A-4□	20	35						4
Single-phase 200V	0.4	CUB3A-1□		10	2.5	2.5	2.5	2.5	0.5	
	0.75	CUB5A-1□	10	16						
	1.5	CUB8A-1□	16	20						4
	2.2	CUB11A-1□	20	35						4

MCCB: Moulded case circuit breaker
RDC: Residual-current-operated protective device
ELCB: Earth leakage circuit breaker

Notes 1) A box (□) in the above table replaces E suffix for filtered version.

*1 The frame size and model of the MCCB or RCD/ELCB (with the exception of those exclusively designed for protection from ground faults) will vary, depending on the power transformer capacity. Refer to the related technical documentation for details.

*2 The recommended wire size for main circuits is for the 70°C 600V PVC wires used at an ambient temperature of 40°C.

*3 Wire sizes are calculated on the basis of the input current under the condition that the power supply capacity and impedance are 500 kVA and 5%, respectively.

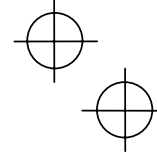
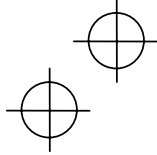
**Conformity to UL standards and Canadian standards (cUL certification)**

If installed according to the guidelines given below, inverters marked with UL/cUL are considered as compliant with the UL and CSA (cUL certified) standards.

⚠ CAUTION

1. Solid state motor overload protection (motor protection by electronic thermal overload relay) is provided in each model.
Use function codes F10 to F12 to set the protection level.
2. Connect the power supply satisfying the characteristics shown in the table below as an input power supply of the inverter. (Short circuit rating)
3. Use 75°C Cu wire only.
4. Use Class 1 wire only for control circuits.
5. Field wiring connection must be made by a UL Listed and CSA Certified closed-loop terminal connector sized for the wire gauge involved. Connector must be fixed using the crimp tool specified by the connector manufacturer.

Short circuit rating

Suitable for use on a circuit capable of delivering not more than B rms symmetrical amperes, A volts maximum.

Power supply voltage	Inverter type	Power supply max. voltage A	Power supply current B
Three-phase 200 V	CUB3A-2□	240 VAC	100,000 A or less
	CUB5A-2□		
	CUB8A-2□		
	CUB11A-2□		
	CUB17A-2□		
Three-phase 400V	CUB1A5-4□	480 VA	100,000 A or less
	CUB2A5-4□		
	CUB3A7-4□		
	CUB5A5-4□		
	CUB9A-4□		
Single-phase 200V	CUB3A-1□	240 VAC	100,000 A or less
	CUB5A-1□		
	CUB8A-1□		
	CUB11A-2□		

Notes 1) A box (□) in the above table replaces E suffix for filtered version

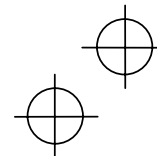
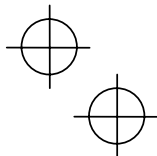

Conformity to UL standards and Canadian standards (cUL certification) (Continued)

⚠ CAUTION

6. Install UL certified fuses between the power supply and the inverter, referring to the table below.

Power supply voltage	Inverter type	Required torque lb-in (N·m)			Wire size AWG or kcmil (mm ²)			Class J fuse current (A)
		Main terminal	Control circuit		Main terminal	Control circuit		
			*1 TERM1	*2 TERM2-1 TERM2-2		*1 TERM1	*2 TERM2-1 TERM2-2	
Three-phase 200V	CUB3A-2□	10.6 (1.2)	3.5 (0.4)	1.8 (0.2)	14	20 (0.5)	10	
	CUB5A-2□						15	
	CUB8A-2□	15.9 (1.8)	3.5 (0.4)	1.8 (0.2)	10	20 (0.5)	20	
	CUB11A-2□						30	
	CUB17A-2□						40	
Three-phase 400V	CUB1A5-4□	15.9 (1.8)	3.5 (0.4)		14	20 (0.5)	3	
	CUB2A5-4□						6	
	CUB3A7-4□						10	
	CUB5A5-4□						15	
	CUB9A-4□						20	
Single-phase 200V	CUB3A-1□	10.6 (1.2)	3.5 (0.4)	1.8 (0.2)	14	20 (0.5)	10	
	CUB5A-1□						15	
	CUB8A-1□	15.9 (1.8)	3.5 (0.4)	1.8 (0.2)	10	20 (0.5)	30	
	CUB11A-1□						40	

Notes 1) A box (□) in the above table replaces E suffix for filtered version.

*1: Denotes the relay contact terminals for 30A, 30B and 30C.

*2: Denotes control terminals except for 30A, 30B and 30C

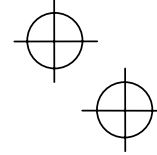
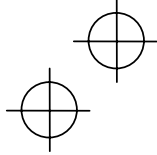

■ Precautions for use

In running general-purpose motors	Driving a 400V general-purpose motor	When driving a 400V general-purpose motor with an inverter using extremely long wires, damage to the insulation of the motor may occur. Use an output circuit filter (OFL) if necessary after checking with the motor manufacturer.
	Torque characteristics and temperature rise	When the inverter is used to run a general-purpose motor, the temperature of the motor becomes higher than when it is operated using a commercial power supply. In the low-speed range, the cooling effect will be weakened, so decrease the output torque of the motor. If constant torque is required in the low-speed range, use an inverter rated motor or a motor equipped with an externally powered ventilating fan.
	Vibration	When an inverter-driven motor is mounted to a machine, resonance may be caused by the natural frequencies of the machine system. Note that operation of a 2-pole motor at 60 Hz or higher may cause abnormal vibration. * The use of a rubber coupling or vibration dampening rubber is recommended. * Use the inverter's jump frequency control feature to skip the resonance frequency zone(s).
	Noise	When an inverter is used with a general-purpose motor, the motor noise level is higher than that with a commercial power supply. To reduce noise, raise carrier frequency of the inverter. Operation at 60 Hz or higher can also result in higher noise level.
In running special motors	High-speed motors	If the set frequency is set to 120 Hz or more to drive a high-speed motor, test-run the combination of the inverter and motor beforehand to check for safe operation.
	Explosion-proof motors	When driving an explosion-proof motor with an inverter, use a combination of a motor and an inverter that has been approved in advance.
	Submersible motors and pumps	These motors have a larger rated current than general-purpose motors. Select an inverter whose rated output current is greater than that of the motor. These motors differ from general-purpose motors in thermal characteristics. Set a low value in the thermal time constant of the motor when setting the electronic thermal function.
	Brake motors	For motors equipped with parallel-connected brakes, their braking power must be supplied from the primary circuit. If the brake power is connected to the inverter's power output circuit by mistake, the brake will not work. Do not use inverters for driving motors equipped with series-connected brakes.

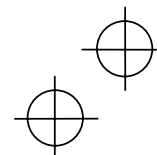
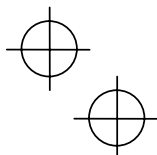

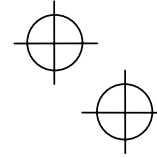
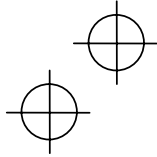

In running special motors	Geared motors	If the power transmission mechanism uses an oil-lubricated gearbox or speed changer/reducer, then continuous motor operation at low speed may cause poor lubrication. Avoid such operation.
	Synchronous motors	It is necessary to take special measures suitable for this motor type. Contact IMO for details.
	Single-phase motors	Single-phase motors are not suitable for inverter-driven variable speed operation. Use three-phase motors. * Even if a single-phase power supply is available, use a three-phase motor as the inverter provides three-phase output.
Environmental conditions	Installation location	Use the inverter within the ambient temperature range from -10 to +50°C. The heat sink and braking resistor of the inverter may become hot under certain operating conditions, so install the inverter on nonflammable material such as metal. Ensure that the installation location meets the environmental conditions specified in Chapter 2, Section 2.1 "Operating Environment."
Combination with peripheral devices	Installing an MCCB or RCD/ELCB	Install a recommended molded case circuit breaker (MCCB) or residual-current-operated protective device (RCD)/earth leakage circuit breaker (ELCB) (with the exception of those exclusively designed for protection from ground faults) in the primary circuit of the inverter to protect the wiring. Ensure that the circuit breaker capacity is equivalent to or lower than the recommended capacity.
	Installing an MC in the secondary circuit	If a magnetic contactor (MC) is mounted in the inverter's secondary circuit for switching the motor to commercial power or for any other purpose, ensure that both the inverter and the motor are completely stopped before you turn the MC on or off. Do not connect a magnet contactor fitted with a surge suppressor to the inverter's secondary circuit.
	Installing an MC in the primary circuit	Do not turn the magnetic contactor (MC) in the primary circuit on or off more than once an hour as an inverter fault may result. If frequent starts or stops are required during motor operation, use FWD/REV signals or the RUN/STOP key.
	Protecting the motor	The electronic thermal function of the inverter can protect the motor. The operation level and the motor type (general-purpose motor, inverter motor) should be set. For high-speed motors or water-cooled motors, set a small value for the thermal time constant and protect the motor. If you connect the motor thermal relay to the motor with a long wire, a high-frequency current may flow into the wiring stray capacitance. This may cause the relay to trip at a current lower than the set value for the thermal relay. If this happens, lower the carrier frequency or use the output circuit filter (OFL).

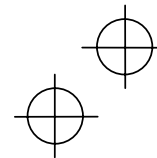
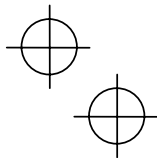

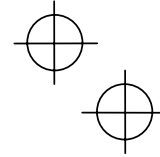
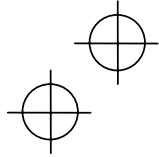

Combina- tion with pe- ripheral de- vices	Discontinuance of power-factor correcting ca- pacitor	Do not mount power-factor correcting capacitors in the in- verter primary circuit. (Use the DC reactor to improve the inverter power factor.) Do not use power-factor correcting capacitors in the inverter output circuit. An overcurrent trip will occur, disabling motor operation.
	Discontinuance of surge killer	Do not connect a surge suppressor to the inverter's sec- ondary circuit.
	Reducing noise	Use of a filter and shielded wires is typically recommended to satisfy EMC directives.
	Measures against surge currents	If an overvoltage trip occurs while the inverter is stopped or operated under a light load, it is assumed that the surge current is generated by open/close of the phase-advancing capacitor in the power system. * Connect a DC reactor to the inverter.
Wiring	Megger test	When checking the insulation resistance of the inverter, use a 500 V megger and follow the instructions contained in Chapter 7, Section 7.4 "Insulation Test."
	Control circuit wiring length	When using remote control, limit the wiring length between the inverter and operator box to 20 m or less and use twisted shielded wire.
	Wiring length between inverter and motor	If long wiring is used between the inverter and the motor, the inverter will overheat or trip as a result of overcurrent (high-frequency current flowing into the stray capacitance) in the wires connected to the phases. Ensure that the wiring is shorter than 50 m. If this length must be exceeded, lower the carrier frequency or mount an output circuit filter (OFL).
	Wiring size	Select wires with a sufficient capacity by referring to the cur- rent value or recommended wire size.
	Wiring type	Do not use one multicore cable in order to connect several inverters with motors.
Selecting inverter capacity	Grounding	Securely ground the inverter using the grounding terminal.
	Driving gen- eral-purpose motor	Select an inverter according to the applicable motor ratings listed in the standard specifications table for the inverter. When high starting torque is required or quick acceleration or deceleration is required, select an inverter with a capacity one size greater than the standard.
Transpor- tation and storage	Driving special motors	Select an inverter that meets the following condition: Inverter rated current > Motor rated current
		When transporting or storing inverters, follow the procedures and select locations that meet the environmental conditions listed in Chapter 1, Section 1.3 "Trans- portation" and Section 1.4 "Storage Environment."

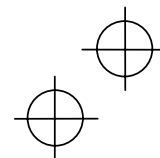
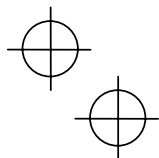

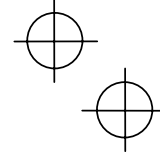
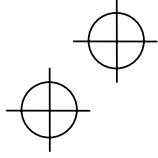

How this manual is organized

This manual is made up of chapters 1 through 10.

Chapter 1 BEFORE USING THE INVERTER

This chapter describes acceptance inspection and precautions for transportation and storage of the inverter.

Chapter 2 MOUNTING AND WIRING OF THE INVERTER

This chapter provides operating environment, precautions for installing the inverter, wiring instructions for the motor and inverter.

Chapter 3 OPERATION USING THE KEYPAD

This chapter describes inverter operation using the keypad. The inverter features three operation modes (Running, Programming and Alarm modes) which enable you to run and stop the motor, monitor running status, set function code data, display running information required for maintenance, and display alarm data.

Chapter 4 OPERATION

This chapter describes preparation to be made before running the motor for a test and practical operation.

Chapter 5 FUNCTION CODES

This chapter provides a list of the function codes. Function codes to be used often and irregular ones are described individually.

Chapter 6 TROUBLESHOOTING

This chapter describes troubleshooting procedures to be followed when the inverter malfunctions or detects an alarm condition. In this chapter, first check whether any alarm code is displayed or not, and then proceed to the troubleshooting items.

Chapter 7 MAINTENANCE AND INSPECTION

This chapter describes inspection, measurement and insulation test which are required for safe inverter operation. It also provides information about periodical replacement parts and guarantee of the product.

Chapter 8 SPECIFICATIONS

This chapter lists specifications including output ratings, control system, external dimensions and protective functions.

Chapter 9 LIST OF PERIPHERAL EQUIPMENT AND OPTIONS

This chapter describes main peripheral equipment and options which can be connected to the Jaguar CUB series of inverters.

Chapter 10 COMPLIANCE WITH STANDARDS

This chapter describes standards with which the Jaguar CUB series of inverters comply.

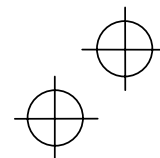
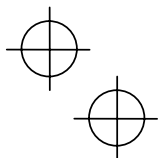

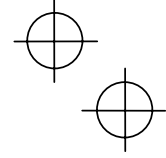
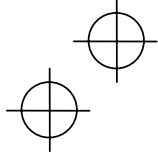



Icons

The following icons are used throughout this manual.

 **Note** This icon indicates information which, if not heeded, can result in the inverter not operating to full efficiency, as well as information concerning incorrect operations and settings which can result in accidents.

 **Tip** This icon indicates information that can prove handy when performing certain settings or operations.

 This icon indicates a reference to more detailed information.

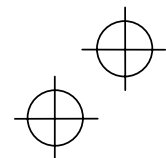
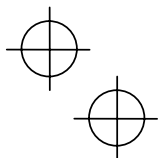
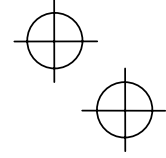
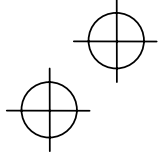
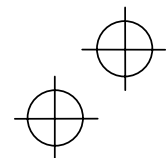
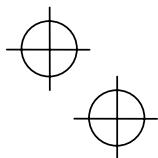

Table of Contents

Preface	i
■ Safety precautions	ii
■ Precautions for use	x
How this manual is organized	xiii
Chapter 1 BEFORE USING THE INVERTER	1-1
1.1 Acceptance Inspection	1-1
1.2 External View and Terminal Blocks	1-2
1.3 Transportation	1-2
1.4 Storage Environment	1-3
1.4.1 Temporary storage	1-3
1.4.2 Long-term storage	1-3
Chapter 2 Mounting and Wiring of the Inverter	2-1
2.1 Operating Environment	2-1
2.2 Installing the Inverter	2-1
2.3 Wiring	2-2
2.3.1 Removing the Terminal Block (TB) Covers	2-2
2.3.2 Terminal Arrangement and Screw Specifications	2-3
2.3.3 Recommended Wire Sizes	2-4
2.3.4 Wiring Precautions	2-6
2.3.5 Wiring for Main Circuit Terminals and Grounding Terminals	2-7
2.3.6 Replacing the Main Circuit Terminal Block (TB) Cover	2-13
2.3.7 Wiring for Control Circuit Terminals	2-14
2.3.8 Switching of SINK/SOURCE (Jumper Switch)	2-20
2.3.9 Installing an RS485 Communications Card (Option)	2-21
2.3.10 Replacing the Control Circuit Terminal Block (TB) Cover	2-21
2.3.11 Cautions Relating to Harmonic Component, Noise, and Leakage Current 2-22	2-22
Chapter 3 OPERATION USING THE KEYPAD	3-1
3.1 Keys, Potentiometer, and LED on the Keypad	3-1
3.2 Overview of Operation Modes	3-2
3.2.1 Running Mode	3-2
3.2.2 Programming Mode	3-3
3.2.3 Alarm Mode	3-4
3.3 Operation in Running Mode	3-6
3.4 Setting the Function Codes-- "Data setting"	3-12
3.5 Checking Changed Function Codes-- "Data checking"	3-15
3.6 Monitoring the Running Status-- "Drive monitoring"	3-16
3.7 Checking I/O Signal Status-- "I/O checking"	3-20
3.8 Reading Maintenance Information--"Maintenance information"	3-23
3.9 Reading Alarm Information-- "Alarm information"	3-25
Chapter 4 RUNNING THE MOTOR	4-1
4.1 Running the motor for a test	4-1
4.1.1 Inspection and Preparation prior to the Operation	4-1
4.1.2 Turning on Power and Checking	4-1
4.1.3 Preparation before running the motor for a test--Setting function code data	4-2
4.1.4 Test run	4-3
4.2 Operation	4-3
Chapter 5 FUNCTION CODES	5-1
5.1 Function Code Tables	5-1
5.2 Overview of Function Codes	5-13
Chapter 6 TROUBLESHOOTING	6-1
6.1 Before Proceeding with Troubleshooting	6-1
6.2 If no alarm code appears on the LED monitor	6-3
6.2.1 Motor is running abnormally	6-3
6.2.2 Problems with inverter settings	6-7
6.3 If an alarm code appears on the LED monitor	6-9
Chapter 7 MAINTENANCE AND INSPECTION	7-1
7.1 Daily Inspection	7-1
7.2 Periodic Inspection	7-1
7.3 Measurement of Electrical Amounts in Main Circuit	7-6
7.4 Insulation Test	7-7
7.5 List of Periodical Replacement Parts	7-8
7.6 Inquiries about Product and Guarantee	7-8
Chapter 8 SPECIFICATIONS	8-1
8.1 Standard Models	8-1
8.1.1 Three-phase 200 V Series	8-1
8.1.2 Three-phase 400 V Series	8-2
8.1.3 Single-phase 200 V Series	8-3
8.2 Models Available on Order	8-4
8.2.1 EMC Filter Built-in Type	8-4
8.2.2 Braking Resistor Built-in Type	8-4
8.3 Common Specifications	8-5
8.4 Terminal Specifications	8-7
8.4.1 Terminal Functions	8-7
8.4.2 Connection Diagram in Operation by External Signal Inputs	8-7
8.5 External Dimensions	8-9
8.5.1 Standard Models and Models Available on Order (Braking Resistor Built-in Type)	8-9
8.5.2 Models Available on Order (EMC Filter Built-in Type)	8-11
8.6 Protective Functions	8-13
Chapter 9 LIST OF PERIPHERAL EQUIPMENT AND OPTIONS	9-1
Chapter 10 COMPLIANCE WITH STANDARDS	10-1
10.1 Compliance with UL Standards and Canadian Standards (cUL certification)	10-1
10.1.1 General	10-1
10.1.2 Considerations when using Jaguar CUB in systems to be certified by UL and cUL 10-1	10-1
10.2 Compliance with European Standards	10-1
10.3 Compliance with EMC Standards	10-2
10.3.1 General	10-2
10.3.2 Recommended installation	10-2
10.4 Harmonic Component Regulation in the EU	10-4
10.4.1 General comments	10-4
10.4.2 Compliance with the harmonic component regulation	10-5



10.5 Compliance with the Low Voltage Directive in the EU	10-5
10.5.1 General	10-5
10.5.2 Points for Consideration when using the Jaguar CUB series in a system to be certified by the Low Voltage Directive in the EU	10-5



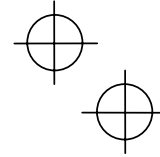
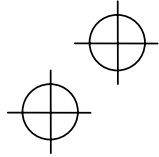

Chapter 1 BEFORE USING THE INVERTER

1.1 Acceptance Inspection

Unpack the package and check that:

- (1) An inverter and instruction manual (this manual) is contained in the package.
- (2) The inverter has not been damaged during transportation—there should be no dents or parts missing.
- (3) The inverter is the model you ordered. You can check the model name and specifications on the main nameplate. (Main and sub nameplates are attached to the inverter and are located as shown on the following page.)



(a) Main nameplate



(b) Sub nameplate

Figure 1.1 Nameplates

TYPE: Type of inverter

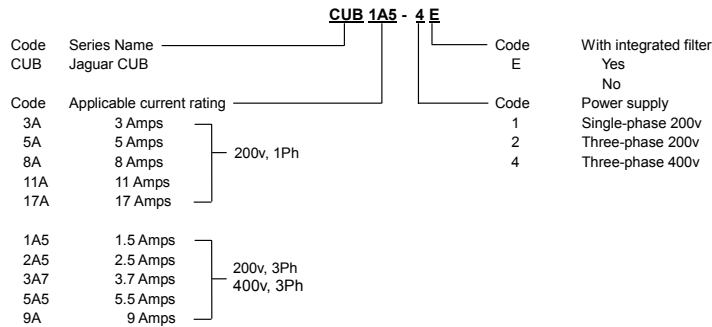

Note: When "None" and "w/o braking resistor (standard)" are selected in the built-in option and brake in the above codes, respectively, the type of inverter is written without the last 2 digits as a standard model.

SOURCE: Number of input phases (three-phase: 3PH, single-phase: 1PH), input voltage, input frequency, input current

OUTPUT: Number of output phases, rated output capacity, rated output voltage, output frequency range, rated output current, overload capacity

SER. No.: Product number

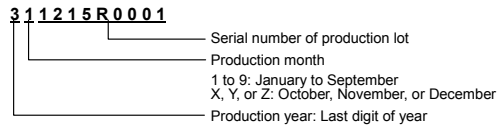

If you suspect the product is not working properly or if you have any questions about your product, contact IMO.

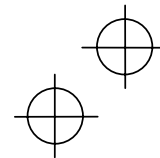
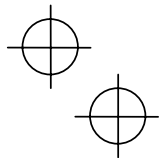

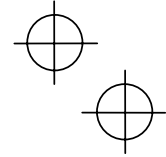
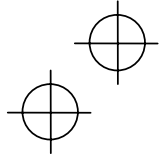

1.2 External View and Terminal Blocks

(1) External views

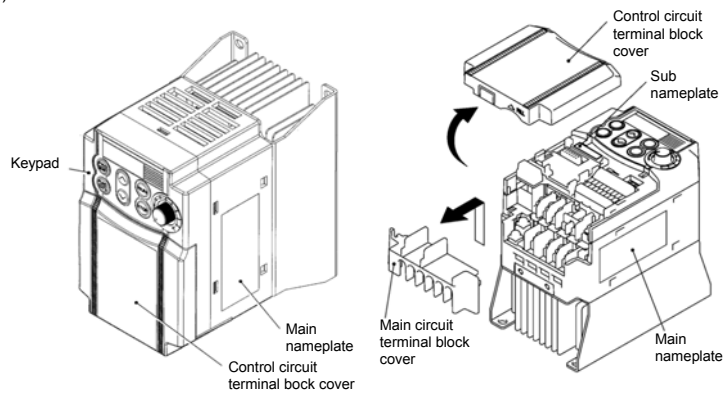
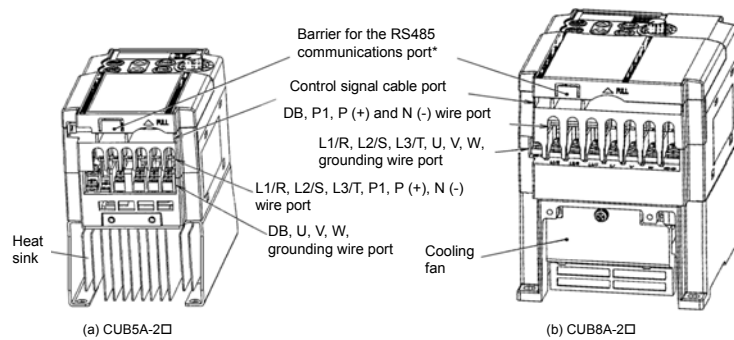

Figure 1.2 External Views of Jaguar CUB

(2) View of terminals



(* When connecting the RS485 communications cable, remove the control circuit terminal block cover and cut off the barrier provided in it using snippers.)

Note: A box (□) in the above model names replaces E suffix for filtered versions.

Figure 1.3 Bottom View of Jaguar CUB

1.3 Transportation

- When carrying the inverter, always support its bottom at the front and rear sides with both hands. Do not hold covers or individual parts only. You may drop the inverter or break it.
- Avoid applying excessively strong force to the terminal block covers as they are made of plastic and are easily broken.

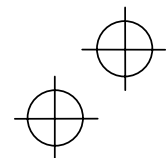
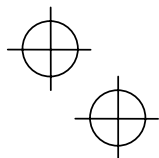

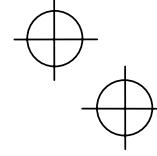
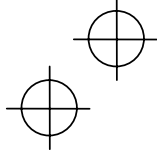

1.4 Storage Environment

1.4.1 Temporary storage

Store the inverter in an environment that satisfies the requirements listed in Table 1.1.

Table 1.1 Environmental Requirements for Storage and Transportation

Item	Requirements	
Storage temperature ^{*1}	-25 to +70°C	Locations where the inverter is not subject to abrupt changes in temperature that would result in the formation of condensation or ice.
Relative humidity	5 to 95% ^{*2}	
Atmosphere	The inverter must not be exposed to dust, direct sunlight, corrosive or flammable gases, oil mist, vapor, water drops or vibration. The atmosphere must contain only a low level of salt. (0.01 mg/cm ³ or less per year)	
Atmospheric pressure	86 to 106 kPa (in storage)	
	70 to 106 kPa (during transportation)	

^{*1} Assuming a comparatively short storage period (e.g., during transportation or the like).

^{*2} Even if the humidity is within the specified requirements, avoid such places where the inverter will be subjected to sudden changes in temperature that will cause condensation to form.

Precautions for temporary storage

- (1) Do not leave the inverter directly on the floor.
- (2) If the environment does not satisfy the specified requirements, wrap the inverter in an airtight vinyl sheet or the like for storage.
- (3) If the inverter is to be stored in an environment with a high level of humidity, put a drying agent (such as silica gel) in the airtight package described in item (2).

1.4.2 Long-term storage

The long-term storage methods for the inverter vary largely according to the environment of the storage site. General storage methods are described below.

- (1) The storage site must satisfy the requirements specified for temporary storage.
However, for storage exceeding three months, the ambient temperature should be within the range from -10 to +30 °C. This is to prevent the electrolytic capacitors in the inverter from deteriorating.
- (2) The inverter must be stored in a package that is airtight to protect it from moisture. Include a drying agent inside the package to maintain the relative humidity inside the package to within 70%.
- (3) If the inverter has been installed in the equipment or control board at a construction site where it may be subjected to humidity, dust or dirt, then remove the inverter and store it in a suitable environment.

Precautions for storage over 1 year

If the inverter will not be powered on for a long time, the property of the electrolytic capacitors may deteriorate. Power the inverters on once a year and keep them on for 30 to 60 minutes. Do not connect the inverters to motors or run the motor.

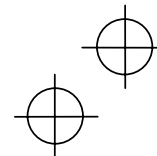
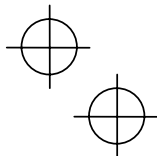

Chapter 2 Mounting and Wiring of the Inverter

2.1 Operating Environment

Install the inverter in an environment that satisfies the requirements listed in Table 2.1.

Table 2.1 Environmental Requirements

Item	Specifications
Site location	Indoors
Ambient temperature	-10 to +50°C (Note 1)
Relative humidity	5 to 95% (No condensation)
Atmosphere	The inverter must not be exposed to dust, direct sunlight, corrosive gases, flammable gas, oil mist, vapor or water drops. (Note 2) The atmosphere must contain only a low level of salt. (0.01 mg/cm ³ or less per year) The inverter must not be subjected to sudden changes in temperature that will cause condensation to form.
Altitude	1,000 m max. (Note 3)
Atmospheric pressure	86 to 106 kPa
Vibration	3 mm (Max. amplitude) 2 to less than 9 Hz 9.8 m/s ² 9 to less than 20 Hz 2 m/s ² 20 to less than 55 Hz 1 m/s ² 55 to less than 200 Hz

Table 2.2 Output Current Derating Factor in Relation to Altitude

Altitude	Output current derating factor
1000 m or lower	1.00
1000 to 1500 m	0.97
1500 to 2000 m	0.95
2000 to 2500 m	0.91
2500 to 3000 m	0.88

(Note 1) When inverters are mounted side-by-side without any gap between them or the NEMA1 kit option is mounted on the inverter, the ambient temperature should be within the range from -10 to +40°C.

(Note 2) Do not install the inverter in an environment where it may be exposed to cotton waste or moist dust or dirt which will clog the heat sink in the inverter. If the inverter is to be used in such an environment, install it in the enclosure of your system or other dustproof containers.

(Note 3) If you use the inverter in altitude above 1000 m, you should apply an output current derating factor as listed in Table 2.2.

2.2 Installing the Inverter

(1) Mounting base

The temperature of the heat sink will rise up to approx. 90°C during operation of the inverter, so the inverter should be mounted on a base made of material that can withstand temperatures of this level.

 WARNING
Install the inverter on a base constructed from metal or other non-flammable material. A fire may result with other material.

(2) Clearances

Ensure that the minimum clearances indicated in Figure 2.1 are maintained at all times. When installing the inverter in the enclosure of your system, take extra care with ventilation inside the enclosure as the temperature around the inverter will tend to increase.



Figure 2.1 Mounting Direction and Required Clearances

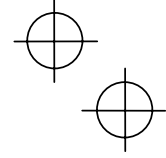
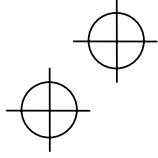

When mounting two or more inverters

Horizontal layout is recommended when two or more inverters are to be installed in the same unit or enclosure. As long as the ambient temperature is 40°C or lower, inverters may be mounted side-by-side without any gap between them. If it is necessary to mount the inverters vertically, install a partition plate or the like between the inverters so that any heat radiating from an inverter will not affect the one/s above.

(3) Mounting direction

Secure the inverter to the mounting base with four screws or bolts (M4) so that the Jaguar CUB logo faces outwards. Tighten those screws or bolts perpendicular to the mounting base.

Note Do not mount the inverter upside down or horizontally. Doing so will reduce the heat dissipation efficiency of the inverter and cause the overheat protection function to operate, so the inverter will not run.

⚠ CAUTION

Prevent lint, paper fibers, sawdust, dust, metallic chips, or other foreign materials from getting into the inverter or from accumulating on the heat sink.
This may result in a fire or accident.

2.3 Wiring

Follow the procedure below. (In the following description, the inverter has already been installed.)

2.3.1 Removing the Terminal Block (TB) Covers

(1) Removing the control circuit terminal block (TB) cover

Insert your finger in the cutout (near "PULL") in the bottom of the control circuit TB cover, then pull the cover towards you.

(2) Removing the main circuit terminal block (TB) cover

Hold both sides of the main circuit TB cover between thumb and forefinger and slide it towards you.

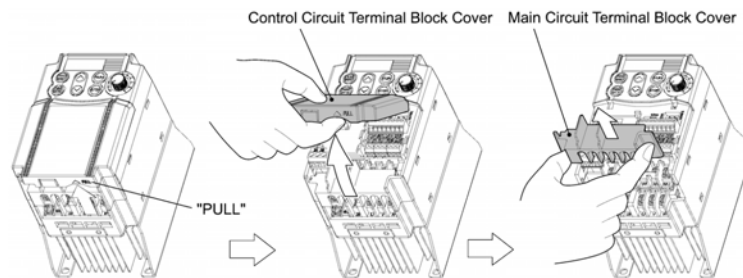
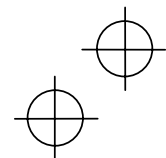
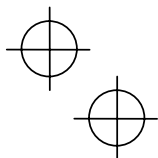
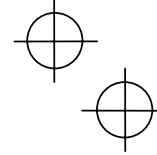
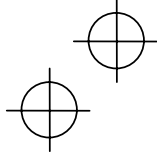



Figure 2.2 Removing the Terminal Block (TB) Covers





2.3.2 Terminal Arrangement and Screw Specifications

The figures below show the arrangement of the main and control circuit terminals which differs according to inverter type. The two terminals prepared for grounding, which are indicated by the symbol  in Figures A to D, make no distinction between the power supply side (primary circuit) and the motor side (secondary circuit).

(1) Arrangement of the main circuit terminals

Table 2.3 Main Circuit Terminals

Power supply voltage	Applicable motor rating (kW)	Inverter type	Terminal screw size	Tightening torque (N·m)	Refer to:
Three-phase 200 V	0.4	CUB3A-2□	M3.5	1.2	Figure A
	0.75	CUB5A-2□			
	1.5	CUB8A-2□			
	2.2	CUB11A-2□			
	4.0	CUB17A-2□			
Three-phase 400 V	0.4	CUB1A5-4□	M4	1.8	Figure B
	0.75	CUB2A5-4□			
	1.5	CUB3A7-4□			
	2.2	CUB5A5-4□			
	4.0	CUB9A-4□			
Single-phase 200 V	0.4	CUB3A-1□	M3.5	1.2	Figure C
	0.75	CUB5A-1□			
	1.5	CUB8A-1□	M4	1.8	Figure D
	2.2	CUB11A-1□			

Note 1) A box (□) in the above table replaces E suffix for filtered version

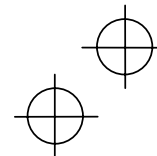
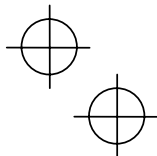
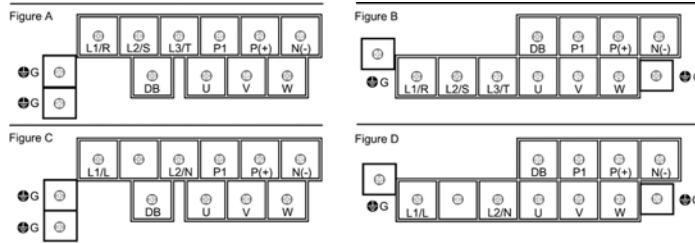

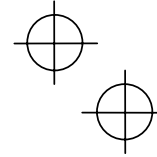
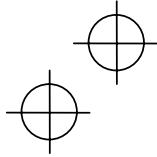

(2) Arrangement of the control circuit terminals (common to all Jaguar CUB models)

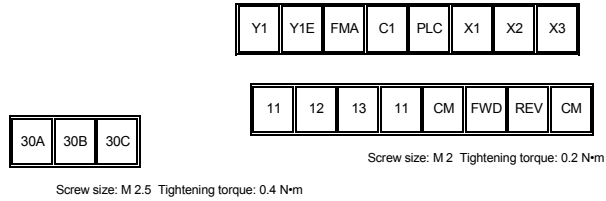

Table 2.4 Control Circuit Terminals

Terminal	Screwdriver to be used	Allowable wire size	Bared wire length	Dimension of openings in the control circuit terminals for stick terminals*
30A, 30B, 30C	Phillips screwdriver (JIS standard) No.1 screw tip	AWG22 to AWG18 (0.34 to 0.75 mm ²)	6 to 8 mm	2.7 mm (W) x 1.8 mm (H)
Others	Phillips screwdriver for precision machinery (JICIS standard) No.0 screw tip	AWG24 to AWG18 (0.25 to 0.75 mm ²)	5 to 7 mm	1.7 mm (W) x 1.6 mm (H)

* Manufacturer of stick terminals: WAGO Company of Japan, Ltd. Refer to Table 2.5.

Table 2.5 Recommended Stick Terminals

Screw size	Wire size	Type (216-□□□)			
		With insulated collar		Without insulated collar	
		Short type	Long type	Short type	Long type
M2	AWG24 (0.25 mm ²)	321	301	151	131
	AWG22 (0.34 mm ²)	322	302	152	132
M2 or M2.5	AWG20 (0.50 mm ²)	221	201	121	101
	AWG18 (0.75 mm ²)	222	202	122	102

The length of bared wires to be inserted into stick terminals is 5.0 mm or 8.0 mm for the short or long type, respectively.

The following crimping tool is recommended: Variocrimp 4 (Part No.: 206-204).

2.3.3 Recommended Wire Sizes

Table 2.6 lists the recommended wire sizes. The wire size for the main circuit denotes the values for HIV and IV solid wires proceeding and following a slash (/), respectively, at an ambient temperature of 50°C.

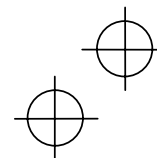
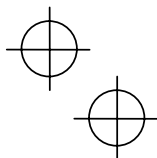

Table 2.6 Recommended Wire Sizes

Power supply voltage	Applicable motor rating (kW)	Inverter type	Recommended wire size (mm ²) ^{*1}					Control circuit
			Main circuit					
			Main circuit power input [L1/R, L2/S, L3/T] [L1/L, L2/N] Grounding [G]		Inverter output [U, V, W]	DCR [P1, P (+)]	Braking resistor [P (+), DB]	
			w/ DCR	w/o DCR ^{*2}				
Three-phase 200 V	0.4	CUB3A-2□	2.0 / 2.0 (2.5)	2.0 / 2.0 (2.5)	2.0 / 2.0 (2.5)	2.0 / 2.0 (2.5)	0.5	
	0.75	CUB5A-2□						
	1.5	CUB8A-2□						
	2.2	CUB11A-2□						
	4.0	CUB17A-2□						
Three-phase 400 V	0.4	CUB1A5-4□	2.0 / 2.0 (2.5)	2.0 / 2.0 (2.5)	2.0 / 2.0 (2.5)	2.0 / 2.0 (2.5)		
	0.75	CUB2A5-4□						
	1.5	CUB3A7-4□						
	2.2	CUB5A5-4□						
	4.0	CUB9A-4□						
Single-phase 200 V	0.4	CUB3A-1□	2.0 / 2.0 (2.5)	2.0 / 2.0 (2.5)	2.0 / 2.0 (2.5)	2.0 / 2.0 (2.5)		
	0.75	CUB5A-1□						
	1.5	CUB8A-1□	2.0 / 3.5 (4.0)	2.0 / 3.5 (4.0)	2.0 / 3.5 (4.0)			
	2.2	CUB11A-1□						

DCR: DC reactor

*1 Use crimp terminals covered with an insulated sheath or insulating tube. Recommended wire sizes are for HIV/IV (PVC in the EU).

*2 Wire sizes are calculated on the basis of input RMS current under the condition that the power supply capacity and impedance are 500 kVA and 5%, respectively.

Note 1) A box (□) in the above table replaces E suffix for filtered version.

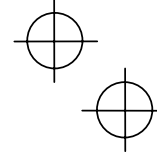
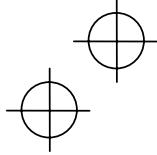

2.3.4 Wiring Precautions

Follow the rules below when performing wiring for the inverter.

- (1) Make sure that the source voltage is within the rated voltage range specified on the nameplate.
- (2) Be sure to connect the power wires to the main circuit power input terminals L1/R, L2/S and L3/T (for three-phase voltage input) or L1/L and L2/N (for single-phase voltage input) of the inverter. If the power wires are connected to other terminals, the inverter will be damaged when the power is turned on.
- (3) Always connect the grounding terminal to prevent electric shock, fire or other disasters and to reduce electric noise.
- (4) Use crimp terminals covered with insulated sleeves for the main circuit terminal wiring to ensure a reliable connection.
- (5) Keep the power supply wiring (primary circuit) and motor wiring (secondary circuit) of the main circuit, and control circuit wiring as far away from each other as possible.

WARNING

- When wiring the inverter to the power source, insert a recommended moulded case circuit breaker (MCCB) or residual-current-operated protective device (RCD)/earth leakage circuit breaker (ELCB) (with the exception of those exclusively designed for protection from ground faults) in the path of power lines. Use the devices within the related current range.
- Use wires in the specified size.
Otherwise, fire could occur.
- Do not use one multicore cable in order to connect several inverters with motors.
- Do not connect a surge killer to the inverter's secondary circuit.
Doing so could cause fire.
- Be sure to connect the grounding wires without fail.
Otherwise, electric shock or fire could occur.
- Qualified electricians should carry out wiring.
- Be sure to perform wiring after turning the power off.
- Ground the inverter according to the requirements of your national and local safety regulations.
Otherwise, electric shock could occur.
- Be sure to perform wiring after installing the inverter body.
Otherwise, electric shock or injuries could occur.
- Check that the number of input phases and the rated voltage of the product match the number of phases and the voltage of the AC power supply to which the product is to be connected.
Otherwise fire or an accident could occur.
- Do not connect the power source wires to output terminals (U, V, and W).
- Do not connect a braking resistor to between terminals P (+) and N (-), P1 and N (-), P (+) and P1, DB and N (-), or P1 and DB.
Doing so could cause fire or an accident.

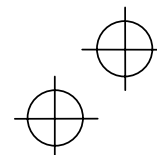
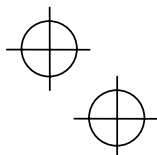

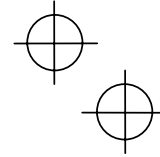
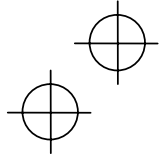

2.3.5 Wiring for Main Circuit Terminals and Grounding Terminals

Follow the procedure below. Figure 2.3 illustrates the wiring procedure with peripheral equipment.

Wiring procedure	
①	Grounding terminals (G)
②	Inverter output terminals (U, V, and W)
③	DC reactor connection terminals (P1 and P(+))*
④	Braking resistor connection terminals (P(+) and DB)*
⑤	DC link circuit terminals (P(+) and N(-))*
⑥	Main circuit power input terminals (L1/R, L2/S and L3/T) or (L1/L and L2/N)

*Perform wiring as necessary.

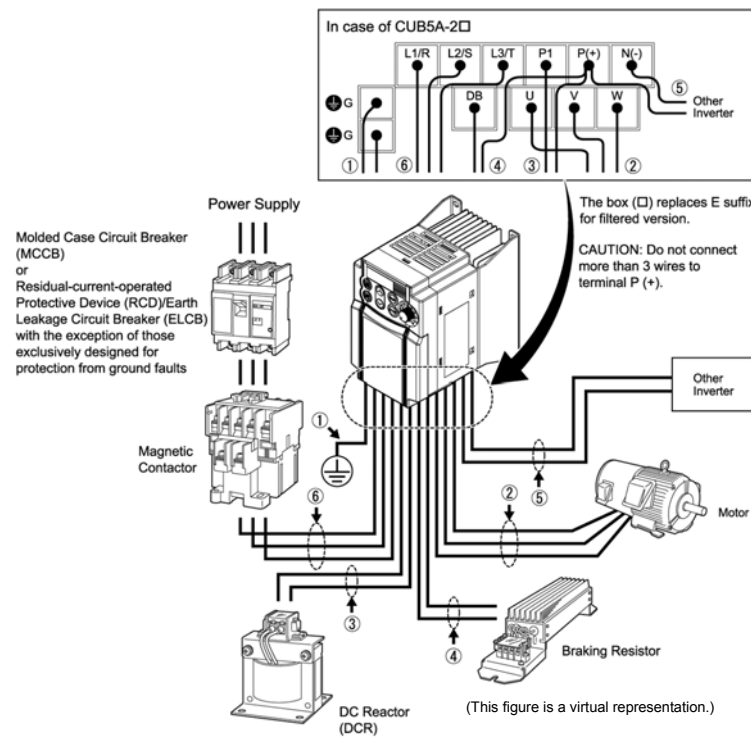
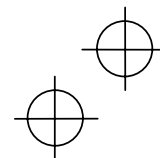
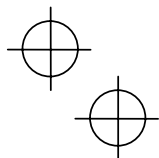
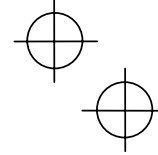
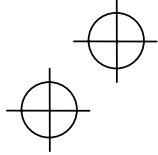

Figure 2.3 Wiring Procedure for Peripheral Equipment





The wiring procedure for the CUB5A-1□ is given below as an example. For other inverter types, perform wiring in accordance with their individual terminal arrangement. (Refer to page 2-3.)

① Grounding terminals (EG)

Be sure to ground either of the two grounding terminals for safety and noise reduction. All metal frames of electrical equipment must be grounded to avoid electric shock, fire and other disasters.

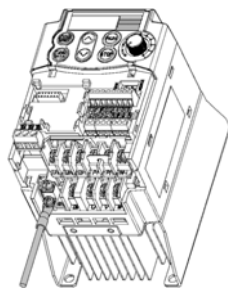

Figure 2.4 Grounding Terminal Wiring

Grounding terminals should be grounded as follows:

- 1) Connect the grounding terminal of the 200 V or 400 V series of inverters to a ground electrode on which class D or C grounding work has been completed, respectively, in compliance with the Electric Facility Technical Standard.
- 2) Connect a thick grounding wire with a large surface area and which meets the grounding resistance requirements listed in Table 2.7. Keep the wiring length as short as possible.

Note Above requirements are for Japan. Ground the inverter according to your national and local safety requirements.

② Inverter output terminals, U, V, and W

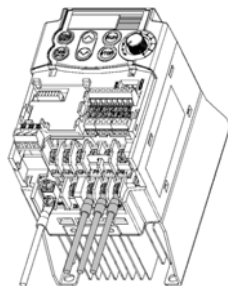
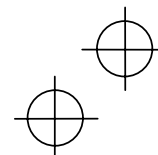
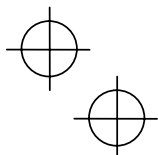
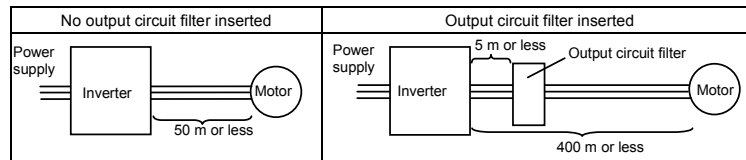
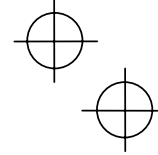
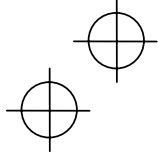

Figure 2.5 Inverter Output Terminal Wiring

- 1) Connect the three wires of the 3-phase motor to terminals U, V, and W.
- 2) The wiring length between the inverter and motor should not exceed 50 m. If the wiring length exceeds 50 m, it is recommended that an output circuit filter (option) be inserted.

Note Do not use one multicore cable to connect several inverters with motors.





- Note**
- Do not connect a condensive capacitor or surge absorber to the inverter output terminals.
 - If the wiring length is long, the stray capacitance between the wires will increase, resulting in an outflow of the leakage current. It will activate the overcurrent protection, increase the leakage current, or will not assure the accuracy of the current display. In the worst case, the inverter could be damaged.
 - If more than one motor is to be connected to a single inverter, the wiring length should be the total length of all motor cables.

- Note** **Driving 400 V series motor**
- If a thermal relay is installed in the path between the inverter and the motor to protect the motor from overheating, the thermal relay may malfunction even with a wiring length shorter than 50 m. In this situation, add an output circuit filter (option) or lower the carrier frequency (Function code F26: Motor sound).
 - If the motor is driven by a PWM-type inverter, surge voltage that is generated by switching the inverter component may be superimposed on the output voltage and may be applied to the motor terminals. Particularly if the wiring length is long, the surge voltage may deteriorate the insulation resistance of the motor. Consider any of the following measures.
 - Use a motor with reinforced insulation.
 - Connect an output circuit filter (option) to the output terminals of the inverter.
 - Minimize the wiring length between the inverter and motor (10 to 20 m or less).

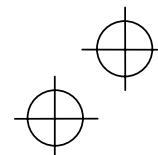
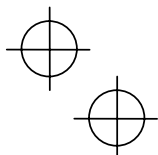

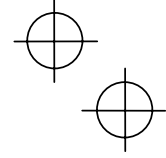
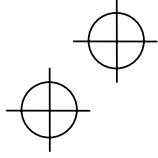

③ DC reactor terminals, P1 and P (+)

- 1) Remove the jumper bar from terminals P1 and P(+).
- 2) Connect a DC reactor (option) to terminals P1 and P(+), if required.



- The wiring length should be 10 m or below.
- If both a DC reactor and a braking resistor are to be connected to the inverter, secure both wires of the DC reactor and braking resistor together to terminal P(+). (Refer to item ④ on the next page.)
- Do not remove the jumper bar if a DC reactor is not going to be used.

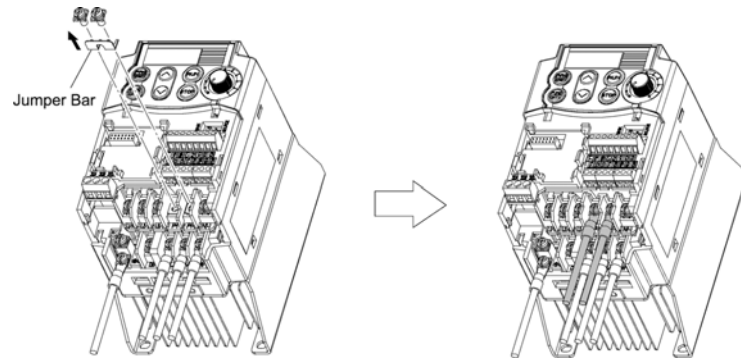
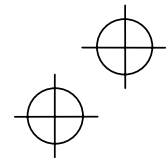
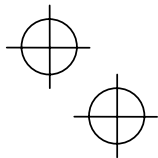
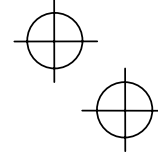
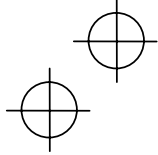

Figure 2.6 DC Reactor Connection





④ **Braking resistor terminals, P(+) and DB**

- 1) Connect terminals P and DB of a braking resistor to terminals P(+) and DB on the main circuit terminal block. (For the braking resistor built-in type, refer to the next page.)
- 2) When using an external braking resistor, arrange the inverter and braking resistor to keep the wiring length to 5 m or less and twist the two wires or route them together in parallel.

⚠ WARNING
<p>Never insert a braking resistor between terminals P(+) and N(-), P1 and N(-), P(+) and P1, DB and N(-), or P1 and DB. Doing so could cause fire.</p>

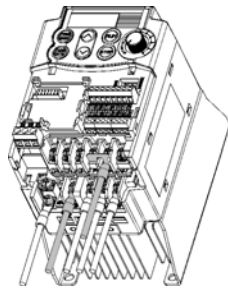

Figure 2.7 Braking Resistor Connection without DC Reactor

When a DC reactor is not to be connected together with the braking resistor

- 1) Remove the screws from terminals P1 and P(+), together with the jumper bar.
- 2) Put the wire from terminal P of the braking resistor and the jumper bar on terminal P(+) in this order, then secure them with the screw removed in 1) above.
- 3) Tighten the screw on terminal P1.
- 4) Connect the wire from terminal DB of the braking resistor to the DB of the inverter.

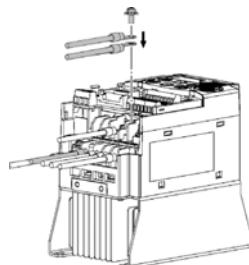

Figure 2.8 Braking Resistor Connection with DC Reactor

When connecting a DC reactor together with the braking resistor

- 1) Remove the screw from terminal P(+).
- 2) Overlap the DC reactor wire and braking resistor wire (P) as shown at left and then secure them to terminal P(+) of the inverter with the screw.
- 3) Connect the wire from terminal DB of the braking resistor to terminal DB of the inverter.
- 4) Do not use the jumper bar.

⑤ **DC link circuit terminals, P (+) and N (-)**

These are provided for the DC bus link circuit system. Connect these terminals with terminals P(+) and N (-) of other inverters.

Note Consult IMO if these terminals are to be used.

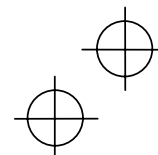
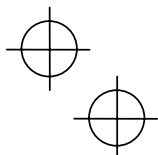

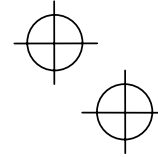
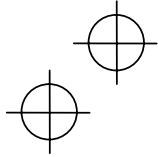

⑥ Main circuit power input terminals, L1/R, L2/S, and L3/T (for three-phase voltage input) or L1/L and L2/N (for single-phase voltage input)

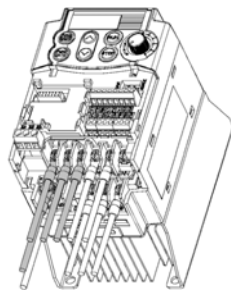

Figure 2.10 Main Circuit Power Input Terminal Connection

- 1) For safety, make sure that the molded case circuit breaker (MCCB) or magnetic contactor (MC) is turned off before wiring the main circuit power input terminals.
- 2) Connect the grounding wire of the main circuit power input terminals (L1/R, L2/S and L3/T or L1/L and L2/N) to the grounding terminal (G).
- 3) Connect the main circuit power supply wires (L1/R, L2/S and L3/T or L1/L and L2/N) to the input terminals of the inverter via an MCCB or residual-current-operated protective device (RCD)/earth leakage circuit breaker (ELCB)*, and MC if necessary.

It is not necessary to align phases of the power supply wires and the input terminals of the inverter with each other.

* With the exception of those exclusively designed for protection from ground faults

Tip It is recommended that a manual on/off magnetic contactor be connected. This is to enable you to disconnect the inverter from the power supply at an emergency (e.g., when the protective function is activated) so as to prevent a failure or accident from causing the secondary problems.

2.3.6 Replacing the Main Circuit Terminal Block (TB) Cover

- 1) As shown in Figure 2.11, pull out the wires from the main circuit terminals in parallel.
- 2) Hold both sides of the main circuit TB cover between thumb and forefinger and slide it back into place. Pull the wires out through the grooves of the main circuit TB cover.

Note Replace the main circuit TB cover, taking care not to apply any stress to the wires. Applying stress to the wires will impose a mechanical force on the screws on the main circuit terminals, which may loosen the screws.

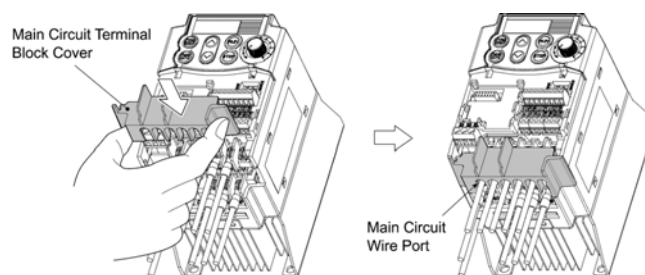
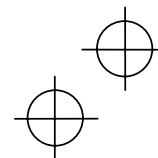
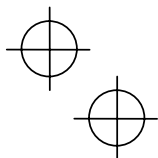
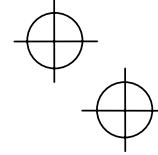
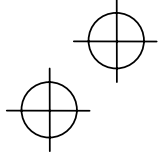

Figure 2.11 Replacing the Main Circuit Terminal Block (TB) Cover





2.3.7 Wiring for Control Circuit Terminals

⚠ WARNING
Generally, the sheath of control circuit wires is not reinforced by any insulation. If the control circuit wires come into direct contact with the live main circuit terminal, therefore, the sheath may break. Accordingly, there is a possibility that high voltage on the main circuit may be applied to the control circuit wires. It is DANGEROUS. Be sure to keep the control wires away from the live main circuit terminals.
An accident or electric shock could occur.

⚠ CAUTION
Noise may be emitted from the inverter, motor and wires.
Implement appropriate measure to prevent the nearby sensors and devices from malfunctioning due to such noise.
An accident could occur.

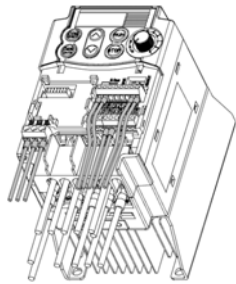

Figure 2.12 Example of Control Circuit Wiring

Table 2.8 lists the symbols, names and functions of the control circuit terminals. The wiring to the control circuit terminals differs depending upon the setting up of the inverter using the function codes.

Basically, replace the main circuit TB cover and then connect wires to the control circuit terminals. As shown in Figure 2.12, pull the wires out through the guides on the main circuit TB cover. Route these wires correctly to reduce the influence of noise, referring to the notes on the following pages.

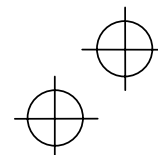
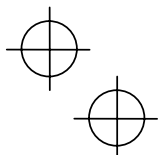
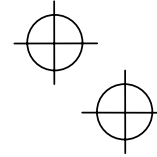
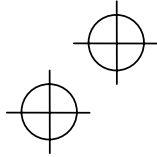

Table 2.8 Symbols, Names and Functions of the Control Circuit Terminals

Classification	Symbol	Name	Functions
Analog input	[13]	Potentiometer power supply	Power supply (+10 VDC) for frequency command potentiometer (Potentiometer: 1 to 5 k Ω) Allowable output current: 10 mA
	[12]	Voltage input	(1) The frequency is set according to the external analog input voltage. 0 to +10 (VDC)/0 to 100 (%) (Normal mode operation) +10 to 0 (VDC)/0 to 100 (%) (Inverse mode operation) (2) Used for reference signal (PID process command) or PID feedback signal. (3) Used as additional auxiliary setting for various main frequency commands. * Input impedance: 22 k Ω * Allowable maximum input voltage is +15 VDC. If the input voltage is +10 VDC or more, the inverter will limit it at +10 VDC.
	[C1]	Current input	(1) The frequency is set according to the external analog input current command. +4 to +20 (mA DC)/0 to 100 (%) (Normal mode operation) +20 to +4 (mA DC)/0 to 100 (%) (Inverse mode operation) (2) Used for reference signal (PID process command) or PID feedback signal. (3) Connects PTC thermistor for motor protection. (4) Used as additional auxiliary setting to various main frequency commands. * Input impedance: 250 Ω * Maximum allowable input current is +30 mA DC. If the input current exceeds +20 mA DC, the inverter will limit it at +20 mA DC.
	[11]	Analog common	Common terminal for analog input and output signals This terminal is electrically isolated from terminals [CM] and [Y1E].



Note

- Since weak analogue signals are handled, these signals are especially susceptible to the external noise effects. Route the wiring as short as possible (within 20 m) and use shielded wires. In principle, ground the shielding layer of the shielded wires; if effects of external inductive noises are considerable, connection to terminal [11] may be effective. As shown in Figure 2.13, ground the single end of the shield to enhance the shielding effect.
- Use a twin contact relay for weak signals if the relay is used in the circuit. Do not connect the relay's contact to terminal [11].
- When the inverter is connected to an external device outputting the analog signal, a malfunction may be caused by electric noise generated by the inverter. If this happens, according to the circumstances, connect a ferrite core (a toroidal core or an equivalent) to the device outputting the analog signal and/or connect a capacitor having the good cut-off characteristics for high frequency between control signal wires as shown in Figure 2.14.
- Do not apply 7.5 V or higher to terminal [C1] continuously. Doing so could damage the internal control circuit.

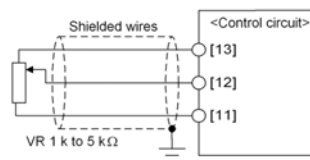

Figure 2.13 Connection of Shielded Wire

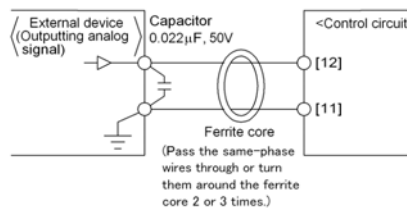

Figure 2.14 Example of Electric Noise Prevention

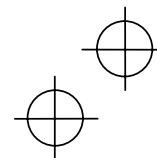
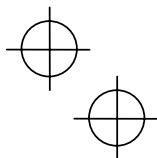
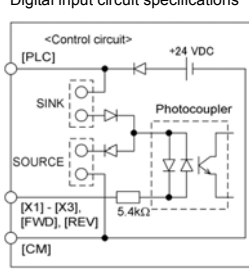
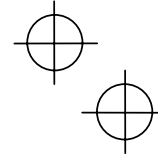
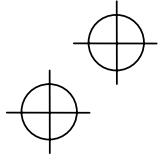

Table 2.8 Continued

Classification	Symbol	Name	Functions
Digital input	[X1]	Digital input 1	(1) The various signals such as coast-to-stop, alarm from external equipment, and multistep frequency selection can be assigned to terminals [X1] to [X3], [FWD] and [REV] by setting function codes E01 to E03, E98, and E99. For details, refer to Chapter 5, Section 5.2 "Overview of Function Codes." (2) Input mode, i.e. Sink/Source, is changeable by using the internal jumper switch.
	[X2]	Digital input 2	
	[X3]	Digital input 3	
	[FWD]	Forward operation command	(3) Switches the logic value (1/0) for ON/OFF of the terminals between [X1] to [X3], [FWD] or [REV], and [CM]. If the logic value for ON between [X1] and [CM] is 1 in the normal logic system, for example, OFF is 1 in the negative logic system and vice versa.
	[REV]	Reverse operation command	(4) The negative logic signaling cannot be applicable to [FWD] and [REV]. Digital input circuit specifications
	[PLC]	PLC signal power	Connects to PLC output signal power supply. (Rated voltage: +24 VDC, Maximum output current: 50 mA)
	[CM]	Digital common	Common terminal for digital input signals This terminal is electrically isolated from terminals [11] and [Y1E].



Item	Min.	Max.
Operation voltage (SINK)	ON level	0V 2V
	OFF level	22V 27V
Operation voltage (SOURCE)	ON level	22V 27V
	OFF level	0V 2V
Operation current at ON (Input Voltage at 0 V)	2.5mA	5mA
Allowable leakage current at OFF	-	0.5mA



Tip If the jumper switch is set at SINK

As shown in Figure 2.15, you can turn digital input terminals [X1] to [X3], [FWD], and [REV] on or off by open collector transistor outputs if you connect the power input (+) of the external device such as a programmable controller to terminal [PLC] that supplies power to the device.
To do so, switch the jumper to SINK.

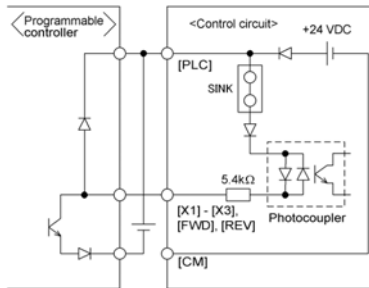

Figure 2.15 External Power Supply Connection

Tip If the jumper switch is set at SOURCE

■ Connecting a relay to the inverter

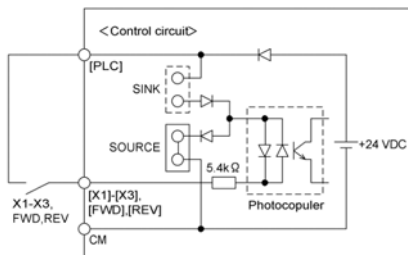

Figure 2.16 (a) Relay Connection

■ Connecting a programmable controller to the inverter

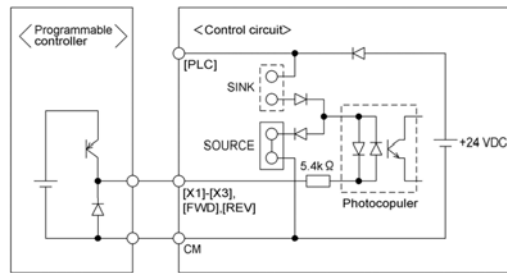

Figure 2.16 (b) Programmable Controller Connection

Note Do not connect terminal [CM] of the inverter to a common terminal of a programmable controller.

Note To turn terminals [X1] to [X3], [FWD], and [REV] on or off with relay contact input, use reliable contacts free from poor contact.

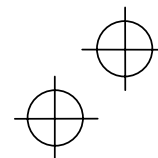
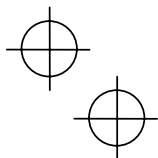

Table 2.8 Continued

Classification	Symbol	Name	Functions														
Analog output	[FMA]	Analog monitor	<p>The monitor signal for analog DC voltage (0 to +10 VDC) is output. The signal functions can be selected from the following with function code F31.</p> <ul style="list-style-type: none"> - Output frequency (before slip compensation) - Output frequency (after slip compensation) - Output current - Output voltage - Input power - PID feedback amount - DC link circuit voltage - Analog output test voltage (+) <p>*Input impedance of external device: Max. 5 kΩ</p>														
	[11]	Analog common	<p>Common terminal for analog input and output signals This terminal is electrically isolated from terminals [CM] and [Y1E].</p>														
Transistor output	[Y1]	Transistor output	<p>(1) Various signals such as inverter running, speed/freq. arrival and over-load early warning can be assigned to the terminal [Y1] by setting function code E20. Refer to Chapter 5, Section 5.2 "Overview of Function Codes" for details.</p> <p>(2) Switches the logic value (1/0) for ON/OFF of the terminals between [Y1] and [Y1E]. If the logic value for ON between [Y1] and [Y1E] is 1 in the normal logic system, for example, OFF is 1 in the negative logic system and vice versa.</p> <p>Digital input circuit specification</p>  <table border="1" data-bbox="925 1108 1189 1276"> <thead> <tr> <th colspan="2">Item</th> <th>Max.</th> </tr> </thead> <tbody> <tr> <td rowspan="2">Operation voltage</td> <td>ON level</td> <td>2V</td> </tr> <tr> <td>OFF level</td> <td>27V</td> </tr> <tr> <td colspan="2">Maximum load current at ON</td> <td>50mA</td> </tr> <tr> <td colspan="2">Leakage current at OFF</td> <td>0.1mA</td> </tr> </tbody> </table> <p>Note</p> <ul style="list-style-type: none"> - Check the polarity of the external power inputs. - When connecting a control relay, first connect a surge-absorbing diode across the coil of the relay. 	Item		Max.	Operation voltage	ON level	2V	OFF level	27V	Maximum load current at ON		50mA	Leakage current at OFF		0.1mA
	Item		Max.														
	Operation voltage	ON level	2V														
OFF level		27V															
Maximum load current at ON		50mA															
Leakage current at OFF		0.1mA															
[PLC] (P24)	Transistor output power	Power source of +24 VDC to be fed to the transistor output circuit load. To enable the source, it is necessary to short-circuit between terminals [Y1E] and [CM].															
	[Y1E]	Transistor output common	<p>Common terminal for transistor output signal This terminal is electrically isolated from terminals [CM] and [11].</p>														

Table 2.8 Continued

Classification	Symbol	Name	Functions
Relay contact output	[30A], [30B], [30C]	Alarm relay output (for any fault)	<ol style="list-style-type: none"> (1) Outputs a contact signal (SPDT) when a protective function has been activated to stop the motor. Contact rating: 250 VAC 0.3A $\cos \phi = 0.3$ +48 VDC, 0.5A (2) A command similar to terminal [Y1] can be selected for the transistor output signal and use it for signal output. (3) Switching of the normal/negative logic output is applicable to the following two contact outputs: "Terminals [30A] and [30C] are short-circuited for ON signal output" or "the terminals [30B] and [30C] are short-circuited (non-excite) for ON signal output."
Communication	RS485 port*	RS485 communications I/O	<ol style="list-style-type: none"> (1) Used to connect the inverter with PC or PLC using RS485 port. (2) Used to connect the inverter with the remote keypad. The inverter supplies the power to the remote keypad through the extension cable for remote keypad.

* This terminal can be used with standard inverters equipped with an RS485 communications card (option).

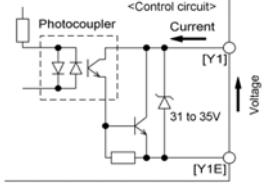

- Route the wiring of the control terminals as far from the wiring of the main circuit as possible. Otherwise electric noise may cause malfunctions.
- Fix the control circuit wires inside the inverter to keep them away from the live parts of the main circuit (such as the terminal block of the main circuit).

2.3.8 Switching of SINK/SOURCE (Jumper Switch)

⚠ WARNING

Before changing the jumper switch, wait for at least five minutes after the power has been turned off, then check that the DC link circuit voltage between main circuit terminals P (+) and N (-) does not exceed the safety voltage (+25 VDC) using a multimeter. An electric shock may result if this warning is not heeded as there may be some residual electric charge in the DC bus capacitor even after the power has been turned off.

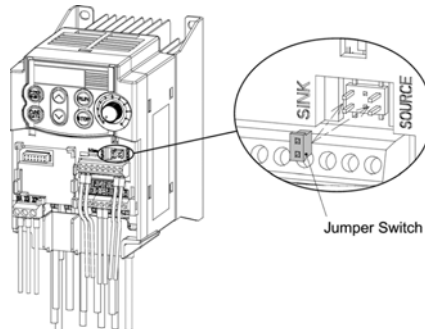

To switch the sink/source of the digital input signal, change the position of the jumper switch using a pair of long-nose pliers, as shown in Figure 2.17.

At the factory setting, the jumper switch is positioned at SOURCE.

Figure 2.17 Switching of SINK/SOURCE (Jumper Switch)

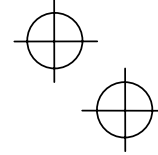
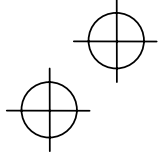

2.3.9 Installing an RS485 Communications Card (Option)

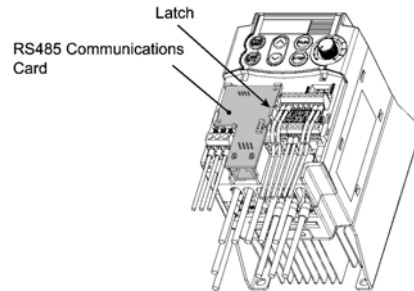

When an optional RS485 communications card is to be used, install it before replacing the main circuit TB cover. Align the card with the latch on the inverter and attach the card to the connector that is located above terminals [30A], [30B] and [30C].

Figure 2.18 Installing an RS485 Communications Card (Option)

⚠ WARNING

After an RS485 communications card is installed, do not remove the control circuit TB cover when the power is turned on since there is high-voltage electronic devices on the RS485 communications card.

Doing so could cause electric shock.

2.3.10 Replacing the Control Circuit Terminal Block (TB) Cover

Upon completion of the wiring of the control circuits, fit the latches provided on the upper end of the control circuit TB cover into the openings in the front face of the inverter, and then close the TB cover.

NOTE: Take care not to pinch the signal lines between the TB cover and inverter body.

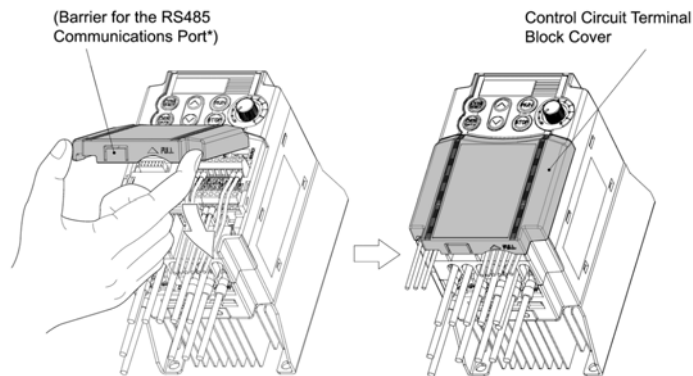

(*When connecting the RS485 communications cable, remove the control circuit TB cover and snip off the barrier of the RS485 communications cable port using nippers.)

Figure 2.19 Replacing the Control Circuit Terminal Block (TB) Cover

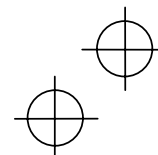
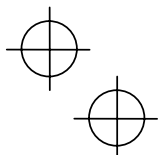

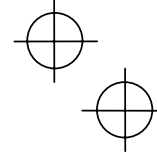
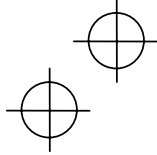

2.3.11 Cautions Relating to Harmonic Component, Noise, and Leakage Current

(1) Harmonic component

Input current to an inverter includes a harmonic component, which may affect other loads and condensive capacitors that are connected to the same power source as the inverter. If the harmonic component causes any problems, connect a DC reactor (option) to the inverter. It may also be necessary to connect an AC reactor to the condensive capacitors.

(2) Noise

If noise generated from the inverter affects other devices, or that generated from peripheral equipment causes the inverter to malfunction, follow the basic measures outlined below.

- 1) If noise generated from the inverter affects the other devices through power wires or grounding wires:
 - Isolate the grounded metal frames of the inverter from those of the other devices.
 - Connect a filter to the inverter power wires.
 - Isolate the power system of the other devices from that of the inverter with an EMC isolating transformer.
- 2) If induction or radio noise generated from the inverter affects other devices through power wires or grounding wires:
 - Isolate the main circuit wires from the control circuit wires and other device wires.
 - Put the main circuit wires through a metal conduit and connect the pipe to the ground near the inverter.
 - Mount the inverter onto a metal board and connect the whole board to the ground.
 - Connect an EMC filter to the inverter power wires.
- 3) When implementing measures against noise generated from peripheral equipment:
 - For the control circuit wires, use twisted or shielded-twisted wires. If using shielded-twisted wires, connect the shield of the shielded wires to the common terminals of the control circuit.
 - Connect a surge absorber in parallel with a coil or solenoid of the magnetic contactor.

(3) Leakage current

Harmonic component current generated by transistors (IGBTs) switching on/off in the inverter forces leakage current through stray capacitors of inverter input and output wires or a motor. If any of the problems listed below occur, take appropriate measures against them.

Table 2.9 Leakage Current Countermeasures

Problem	Measures
An earth leakage circuit breaker* that is connected to the power supply has isolated the inverter from the power supply. * With the exception of those exclusively designed for protection from ground faults	<ol style="list-style-type: none">1) Decrease the carrier frequency.2) Make the wires between the inverter and motor shorter.3) Use an earth leakage circuit breaker that has a larger current sensitivity than one currently being used.4) Use an earth leakage circuit breaker that features measures against harmonic component.
An external thermal relay was activated.	<ol style="list-style-type: none">1) Decrease the carrier frequency.2) Increase thermal time constant.3) Use the thermal relay built in the inverter.

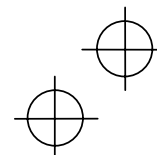
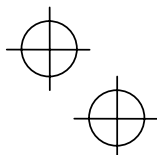

Chapter 3 OPERATION USING THE KEYPAD

3.1 Keys, Potentiometer, and LED on the Keypad

As shown in the figure at right, the keypad consists of a four-digit LED monitor, a potentiometer (POT), and six keys.

The keypad allows you to start and stop the motor, monitor running status, and switch to the menu mode. In the menu mode, you may set the function code data, monitor I/O signal states, maintenance information, and alarm information.



Table 3.1 Overview of Keypad Functions

Monitor, Potentiometer and Keys	Functions
	<p>Four-digit, 7-segment LED monitor which displays the following according to the operation modes*.</p> <ul style="list-style-type: none"> ■ In Running mode: Running status information (e.g., output frequency, current, and voltage) ■ In Programming mode: Menu, function codes and their data ■ In Alarm mode: Alarm code which identifies the error factor if the protective function is activated.
	Potentiometer (POT) which is used to manually set frequency, auxiliary frequencies 1 and 2 or PID process command.
	RUN key. Press this key to run the motor.
	STOP key. Press this key to stop the motor.
	UP/DOWN keys. Press these keys to select the setting items and change the function data displayed on the LED monitor.
	<p>Program/Reset key which switches the operation modes* of the inverter.</p> <ul style="list-style-type: none"> ■ In Running mode: Pressing this key switches the inverter to Programming mode. ■ In Programming mode: Pressing this key switches the inverter to Running mode. ■ In Alarm mode: Pressing this key after removing the error factor will switch the inverter to Running mode.
	<p>Function/Data key which switches the operation you want to do in each mode as follows:</p> <ul style="list-style-type: none"> ■ In Running mode: Pressing this key switches the information displayed (output frequency (Hz), current (Amps) or voltage (V)). ■ In Programming mode: Pressing this key displays the function code and sets the data entered with the and keys or the POT. ■ In Alarm mode: Pressing this key displays information concerning the alarm code currently displayed on the LED monitor.

* Jaguar CUB features three operation modes—Running, Programming, and Alarm modes. Refer to Section 3.2 "Overview of Operation Modes."

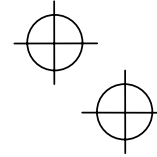
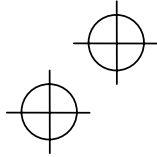

Simultaneous keying

Simultaneous keying means depressing two keys at the same time (expressed by "+"). Jaguar CUB supports simultaneous keying as listed below.

(For example, the expression "STOP + FWD keys" stands for pressing the FWD key while holding down the STOP key.)

Operation modes	Simultaneous keying	Used to:
Running mode	STOP + FWD keys	Control entry to/exit from jogging operation.
Programming mode	STOP + FWD keys	Change special function code data. (Refer to codes F00 and H03 in Chapter 5 "FUNCTION CODES.")
Alarm mode	STOP + FWD keys	Switch to Programming mode without resetting the alarm.

3.2 Overview of Operation Modes

Jaguar CUB features the following three operation modes:

- Running mode : This mode allows you to enter run/stop commands in regular operation. You may also monitor the running status in realtime.
- Programming mode : This mode allows you to set function code data and check a variety of information relating to the inverter status and maintenance.
- Alarm mode : If an alarm occurs, the inverter automatically enters this Alarm mode in which the corresponding alarm code* and its related information may be displayed on the LED monitor.

*Alarm code: Shows the error factor that has activated the protective function. For details, refer to Chapter 8, Section 8.6 "Protective Functions."

Figure 3.1 shows the status transition of the inverter between these three operation modes.

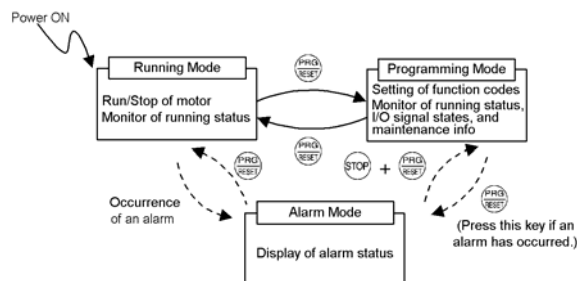

Figure 3.1 Status Transition between Operation Modes

3.2.1 Running Mode

If the inverter is turned on, it automatically enters Running mode in which you may:

- (1) Run/stop the motor
- (2) Set up the set frequency and others
- (3) Monitor the running status (e.g., output frequency, output current)
- (4) Jog (inch) the motor

For details, refer to Section 3.3, "Operation in Running mode."

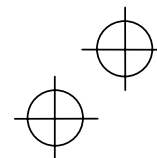
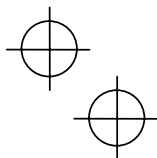

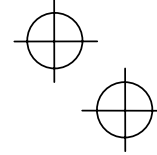
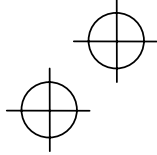

3.2.2 Programming Mode

Programming mode provides you with these functions--setting and checking function code data, monitoring maintenance information and checking input/output (I/O) signal status. The functions can be easily selected with the menu-driven system. Table 3.2 lists menus available in Programming mode. The leftmost digit (numerals) of each letter string indicates the corresponding menu number and the remaining three digits indicate the menu contents.

When the inverter enters Programming mode from the second time on, the menu that was selected last in Programming mode will be displayed.

Table 3.2 Menus Available in Programming Mode

Menu #	Menu	LED monitor shows:	Main functions	Refer to:	
#1	"Data setting"	1.F__	F codes (Fundamental functions)	Selecting each of these function codes enables its data to be displayed/changed.	Section 3.4
		1.E__	E codes (Extension terminal functions)		
		1.C__	C codes (Control functions of frequency)		
		1.P__	P codes (Motor parameters)		
		1.H__	H codes (High performance functions)		
		1.J__	J codes (Application functions)		
		1.y__	y codes (Link functions)		
#2	"Data checking"	2.rEP	Displays only function codes that have been changed from their factory defaults. You may refer to or change those function codes data.	Section 3.5	
#3	"Drive monitoring"	3.oPE	Displays the running information required for maintenance or test running.	Section 3.6	
#4	"I/O checking"	4. i_o	Displays external interface information.	Section 3.7	
#5	"Maintenance information"	5.CHE	Displays maintenance information including accumulated run time.	Section 3.8	
#6	"Alarm information"	6.AL	Displays the latest four alarm codes. You may refer to the running information at the time when the alarm occurred.	Section 3.9	
#7	"Data copying"	7.CPy	Allows you to read or write function code data, as well as verifying it.*	--	

* To use this function, you will need a remote keypad (option).

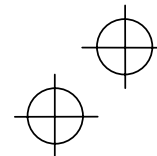
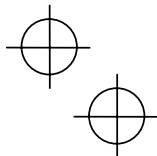

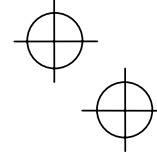
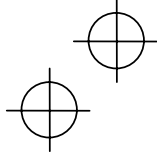

Limiting menus to be displayed

The menu-driven system has a limiter function (specified by function code E52) that limits menus to be displayed for the purpose of simple operation. The factory default is to display Menu #1 "Data setting" only, allowing no switching to any other menu.

Function Code E52 – Keypad (Mode Selection)

Function code data (E52)	Menus selectable
0: Function code data setting mode	Menu #1 "Data setting" (factory default)
1: Function code data check mode	Menu #2 "Data checking"
2: Full-menu mode	Menu #1 through #6 (#7*)

* Menu #7 appears only when the remote keypad (option) is set up for use.

If the full-menu mode is selected, pressing the or key will cycle through menus. With the key, you may select the desired menu. Once all of the menus have been cycled through, the display will return to the first menu.

3.2.3 Alarm Mode

When the protective function is activated to issue an alarm, the inverter automatically transfers to Alarm mode and the alarm code will appear in the LED monitor. Figure 3.2 shows the status transition of Alarm mode.

Releasing the Alarm and Transferring the Inverter to Running Mode

Remove the cause of the alarm and press the key to release the alarm and return to Running mode. The alarm can only be removed using the key when the alarm code is displayed.

Displaying the Alarm History

It is possible to display the most recent 3 alarm codes in addition to the one currently displayed. Previous alarm codes can be displayed by pressing the or key while the current alarm code is displayed.

Displaying the Running Information when an Alarm Occurs

If an alarm occurs, you may check various running status information (output frequency and output current, etc.) by pressing the key when the alarm code is displayed. The item number and data for each running information is displayed in alternation.

Further, you can switch between the various running information using the or key. Detailed running information is the same as for Menu #6 "Alarm information" in Programming mode. Refer to Table 3.14 in Section 3.9 "Reading Alarm Information."

Pressing the key while the running information is displayed returns the display to the alarm codes.

Note When the running information is displayed after removal of the alarm cause, pressing the key twice in succession will cause the inverter to transmit to the alarm code display and then release the alarm status. Be careful with a run command. If a run command has been entered at this stage, the motor will start running.

Transit to Programming Mode

Further, it is also possible to switch the inverter to Programming mode by pressing the + keys simultaneously while the alarm is displayed and to then check and adjust the function code data.

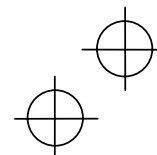
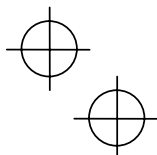

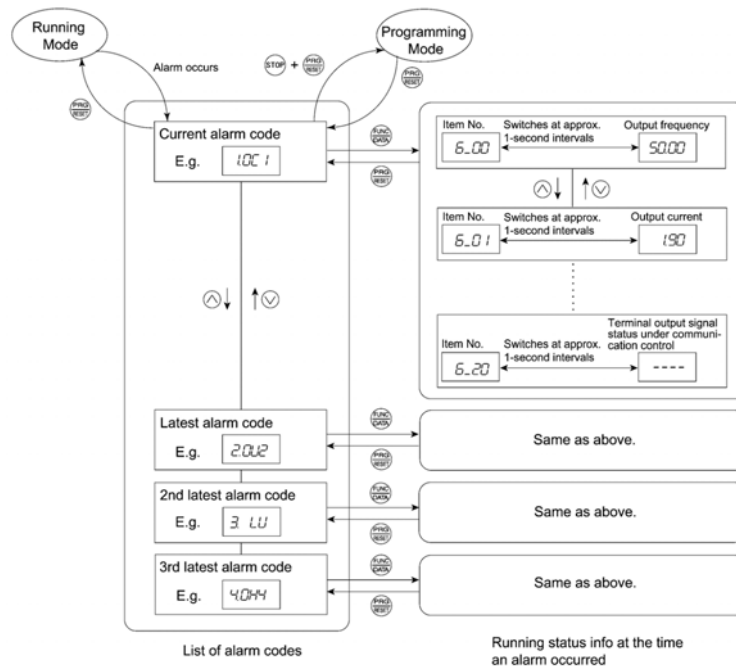
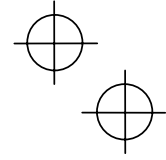
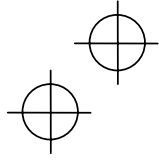
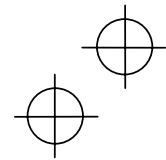
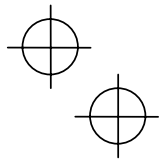
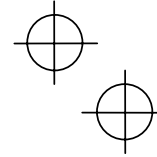
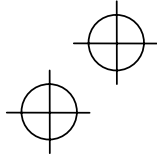

Figure 3.2 Alarm Mode Status Transition





3.3 Operation in Running Mode

If the inverter is turned on, it automatically enters Running mode in which you may operate the following:

(1) Run/Stop the Motor

By factory default, pressing the key starts running the motor in the forward direction and pressing the key decelerates the motor to stop. The key is enabled only in Running mode.

Changing function code F02 data makes it possible to run the motor in the reverse direction by pressing the key, determine the motor rotation direction by entering input signals to the terminals, and control the motor by pressing the keys.



■ Operational relationship between function code F02 (Running/Stopping and Rotational Direction) and key

If Function code F02 is set to:	Pressing the key rotates the motor:
2	in the forward direction
3	in the reverse direction

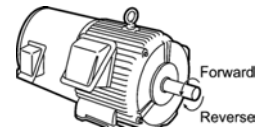

For setting "0" or "1" to F02, refer to Chapter 5 for details.

(2) Set up the Set Frequency and Others

By using the potentiometer and keys on the keypad, you may set up the desired set frequency and PID process commands. It is also possible to set up the set frequency as frequency, load shaft speed, line speed, and constant rate of feeding time by setting function code E48.



Setting up the set frequency with the built-in potentiometer (factory default)

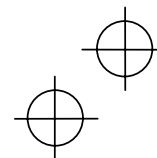
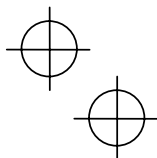

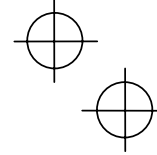
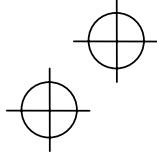

If you set function code F01 to "4: Enable the built-in potentiometer" (factory default) and select frequency command 1 with function codes E01 through E03 (Hz2/Hz1 = OFF), then the potentiometer becomes enabled to set up the set frequency.













Setting the set frequency with the and keys

If you set function code F01 to "0: Keypad operation" and select frequency command 1, then the  and  keys become enabled to set the set frequency in Running mode. In any other operation modes, those keys remain disabled.

Pressing the  or  key calls up the set frequency with the lowest digit blinking. Pressing the  or  key again makes it possible to change the set frequency. The new setting will be saved internally. Even if the inverter is switched to any other frequency entry and then returned to keypad entry, the setting will be retained.



Further, even turning off the inverter will automatically save the setting into the non-volatile memory. The next time the inverter is turned on, the setting will become the default frequency.

If you set function code F01 to "0: Keypad operation" but do not select frequency command 1 (e.g., you select frequency command 2, communication control, or multistep frequency), then the  and  keys cannot be used for setting the set frequency. Pressing those keys will just display the currently selected set frequency.

-  **Tip** • When setting the frequency and others with the  and  keys, the lowest digit on the display will blink. Change the setting, starting with the lowest digit and the blinking digit (cursor) will move to the next upper digit.
- If you press the  or  key once for changing the set frequency or other data and then hold down the  key for 1 second or longer after the lowest digit starts blinking, the blinking digit will move to the next upper digit so that you may easily access and change higher data values. (Cursor movement)

To set up the set frequency from any other displayed items, it is dependent on function code E48 data (= 4, 5, or 6) "LED monitor details (Select speed monitor)" as listed in the following table.

E48 data "LED monitor details (Select speed monitor)"	Set frequency display	Conversion of displayed value
0: Output frequency (before slip compensation)	Frequency setting	
1: Output frequency (after slip compensation)	Frequency setting	
2: Set frequency	Frequency setting	
4: Load shaft speed	Load shaft speed setting	Frequency setting × E50
5: Line speed	Line speed setting	Frequency setting × E50
6: Constant rate of feeding time	Constant rate of feeding time setting	$\frac{E50}{\text{Frequency setting} \times E39}$



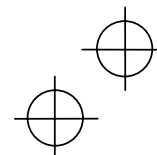
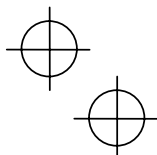

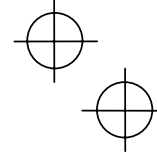
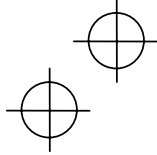
If you set function code C30 data to "0: Keypad operation" and select frequency command 2, then the  and  keys become also enabled to set up the set frequency.





■ Make setting under PID control

To enable PID control, you need to set function code J01 to 1 or 2.





Under the PID control, the items that can be set or checked with the  and  keys are different from those under regular frequency control, depending upon the current LED monitor setting. If the LED monitor is set to the speed monitor (E43 = 0), you may access manual feed commands (Set frequency) with the  and  keys; if it is set to any other, you may access PID process commands with those keys.

Setting the PID process command with the built-in potentiometer

- (1) Set function code E60 to "3: PID process command 1."
- (2) Set function code J02 to "1: PID process command 1. "



Setting the PID process command with the and keys

- (1) Set function code J02 to "0: Keypad operation."
- (2) Set the LED monitor to the setting other than the speed monitor (E43 = 0) in Running mode.
This setting is possible only in Running mode.

Pressing the  or  key displays the PID process command with the lowest digit blinking on the LED monitor. Pressing the  or  key again makes it possible to change the PID process command. Once the PID process command is modified, it will be saved internally. Even if the inverter is switched to any other PID process command entry and then returned to the keypad entry, the setting will be retained.

Further, even turning off the inverter will automatically save the setting into the non-volatile memory. At the next time when the inverter is turned on, the setting will become the default PID process command.



Even if the PID process command is selected ((SS4) = ON) in the multistep frequency, it is still possible to set the process command using the keypad.

When function code J02 data has been set to any value except 0, pressing the  or  key displays the PID process command currently selected (setting is not possible).

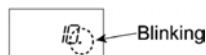
When the PID process command is displayed, the decimal point next to the lowest digit on the LED display blinks to discriminate it from the regular frequency setting.



Setting up the set frequency with the and keys under the PID control

To set the set frequency with the  and  keys under the PID control, you need to specify the following conditions:

- Set function code F01 to "0: Keypad operation."
- Select frequency command 1 (Frequency settings from communications link: Disabled, and Multistep frequency settings: Disabled) as manual speed command.
- Set the LED monitor to the speed monitor in Running mode.

The above setting is impossible in any operation mode except Running mode.

The setting procedure is the same as that for usual frequency setting.

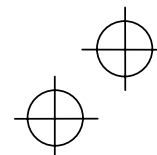
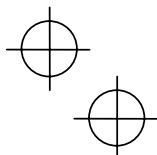

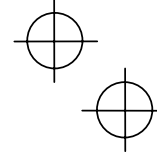
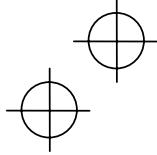

If you press the or key in any conditions other than those described above, the following will appear:

Frequency command 1 (F01)	Frequency setting from communications link	Multistep frequency setting	PID control cancelled	Displayed using or key
0	Disabled	Disabled	PID enabled	Frequency setting by keypad
			Cancelled	
Other than the above			PID enabled	PID output (as final frequency setting)
			Cancelled	Manual speed command currently selected (frequency setting)

(3) Monitor the Running Status

In Running mode, the seven items listed below can be monitored. Immediately after the inverter is turned on, the monitor item specified by function code E43 is displayed. Press the key to switch between monitor items.

Table 3.3 Monitor Items

Monitor Items	Display Sample on the LED monitor	Meaning of Displayed Value
Speed monitor (Hz, rpm, m/min, min)	50.00	Refer to Table 3.4.
Output current (A)	1.90A	Detected output current. A: An alternative expression for A (ampere)
Input power (kW)	0.40P	Detected input current to the inverter in Amp. P: An alternative expression for kW (kilo watt)
Output voltage (V)	200U	Commanded output voltage. U: An alternative expression for V (voltage)
PID process command (Note 1)	10.00. (Note 2)	(PID process command or PID feedback amount) × (PID display coefficient A – B) + B PID display coefficients A and B: Refer to function codes E40 and E41
PID feedback amount (Note 1)	9.00. (Note 3)	
Timer (sec) (Note 1)	6 (Note 4)	Remaining effective timer count

(Note 1) The PID process command and PID feedback amount are displayed only under the PID control using a process command (J01 = 1 or 2). Further, the timer (for timer operation) is only displayed when timer is enabled (C21 = 1).

(Note 2) The dot in the lowest digit will blink.

(Note 3) The dot in the lowest digit will light.

(Note 4) A positive integer is displayed.

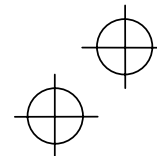
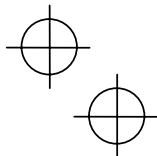

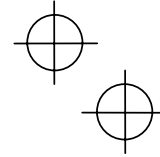
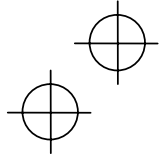
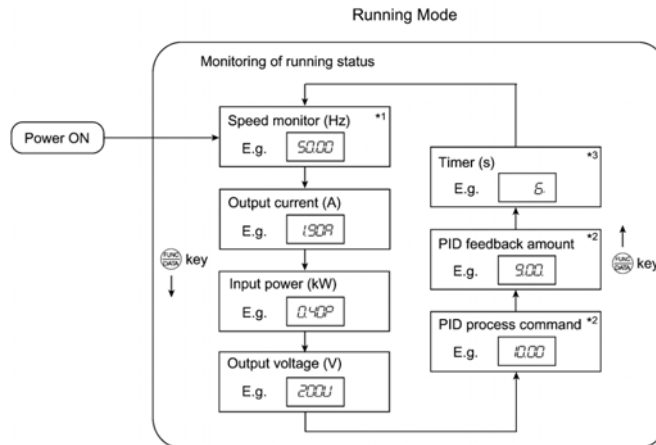

Figure 3.3 shows the procedure for selecting the desired monitor item.



*1 The speed monitor may display the output frequency (Hz), set frequency (Hz), load shaft speed (rpm), line speed (m/min.), and constant rate of feeding time (min.) which can be selected by setting up function code E48.

*2 These PID-related information will appear only when the inverter is under the PID control. (Refer to Section 3.3.)

*3 This will appear only when timer operation is enabled by setting up function code C21. (Refer to Chapter 5.)

Figure 3.3 Monitor Item Selection Example

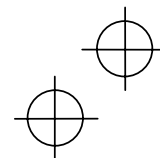
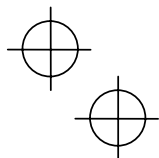

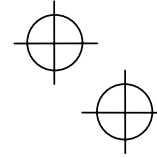
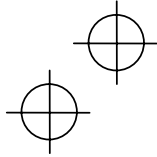

Table 3.4 lists the display items for the speed monitor that can be chosen with function code E48. (Refer to Chapter 5.)

Table 3.4 Display Items on the Speed Monitor

Speed monitor items	Function code E48 data	Meaning of Displayed Value
Output frequency (before slip compensation) (Hz) (Factory default)	0	Before slip compensation
Output frequency (after slip compensation) (Hz)	1	Frequency actually being outputted
Set frequency (Hz)	2	Final set frequency
Load shaft speed (rpm)	4	Display value = Output frequency (Hz) x E50
Line speed (m/min)	5	Display value = Output frequency (Hz) x E50
Constant rate of feeding time (min)	6	Display value = $\frac{E50}{\text{Output frequency} \times E39}$

Output frequencies contained in these formulas are output frequencies before slip compensation.

(4) Jog (Inch) the Motor

To jog the motor, follow the procedure given below.

- ① Making the inverter ready for jogging (The *JoG* appears on the LED monitor.)

- 1) Switch to Running mode. (Refer to page 3-2 for details.)
- 2) Press the + keys at the same time (simultaneous keying).

The LED monitor shows the jogging frequency for approx. 1 second and returns to the *JoG* display.

- Tip**
- During jogging, the jogging frequency (C20) and acceleration/deceleration time for jogging (H54) will apply. They are exclusively prepared for jogging and required to be set up individually.
 - Using the external input signal command (JOG) also allows the transition between the ready-to-jog state and usual running state.
 - The transition (+) between the ready-to-jog state and usual running state is enabled only when the inverter is not in operation.

- ② Jogging the motor

- 1) The inverter will jog the motor only while the key is held down, and contrarily the moment the key is released, the inverter will decelerate and stop the motor.

- ③ Exiting the ready-to-jog state

- 1) Press the + keys at the same time (simultaneous keying).

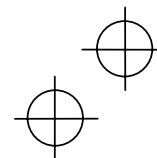
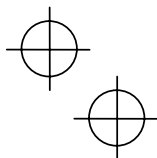

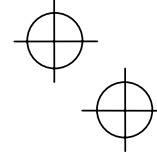
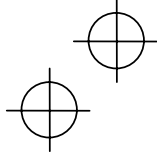

3.4 Setting the Function Codes--"Data setting"

Menu #1 "Data setting" in Programming mode allows you to set function codes for making the inverter functions match your needs.

To set function codes in Menu #1 "Data setting," it is necessary to set function code E52 data to 0 (Function code data setting) or 2 (Full-menu mode).

The table below lists the function codes available in the Jaguar CUB. The function codes are displayed on the LED monitor on the keypad as shown below.

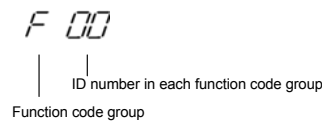

Table 3.5 List of Jaguar CUB Function Codes

Function code group	Function code	Function	Description
F codes (Fundamental functions)	F00 to F51	Basic functions	To be used for basic motor running.
E codes (Extension terminal functions)	E01 to E99	Terminal functions	To be used to select the functions of the control circuit terminals. To be used to set functions related to the LED monitor display.
C codes (Control functions of frequency)	C01 to C52	Frequency control functions	To be used to set application functions related to frequency settings.
P codes (Motor parameters)	P02 to P99	Motor parameters	To be used to set special parameters for the motor capacity, etc.
H codes (High performance functions)	H03 to H98	High level functions	To be used for high added value functions and complicated control, etc.
J codes (Application functions)	J01 to J06	Application functions	To be used for PID control.
y codes (Link functions)	y01 to y99	Link functions	To be used for communications

Refer to Chapter 5 "FUNCTION CODES" for details on the function codes.

Function codes that require simultaneous keying

To change data for function codes F00 (Protect data), H03 (Initialize data), and H97 (Clear alarm data) simultaneous keying operation is necessary--STOP + keys or STOP + keys. This prevents data from being lost by mistake.

Changing, validating, and saving function code data when the motor is running

Some function code data can be changed while the motor is running and some cannot. Further, amongst the function codes whose data can be changed while the motor is running, there are some for which the changes can be validated immediately and others for which they cannot. Refer to the "Change when running" column in Chapter 5, Section 5.1 "Function Code Tables."

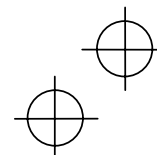
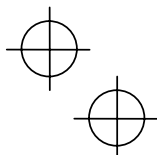

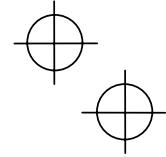
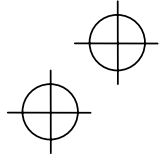

Figure 3.4 shows the status transition for Menu #1 "Data setting" and Figure 3.5 shows an example of the function code data changing procedure.

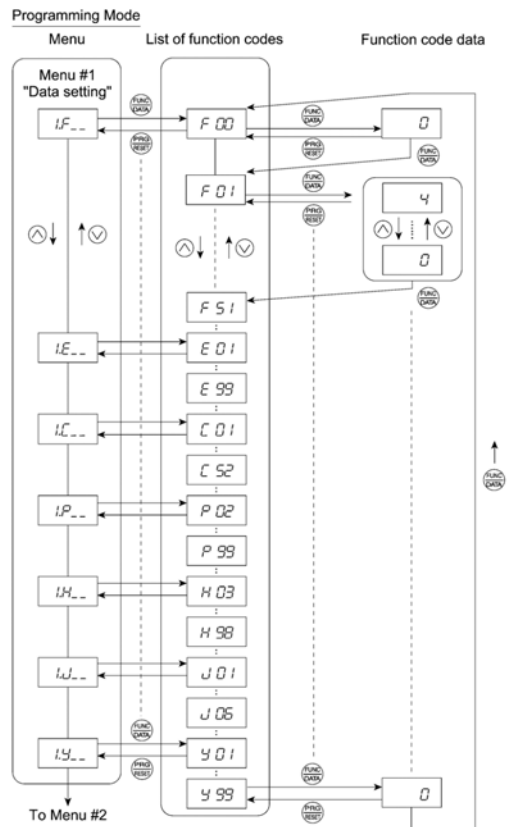
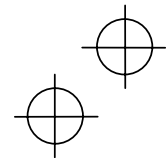
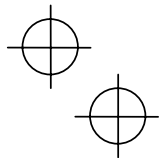
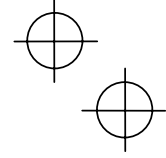
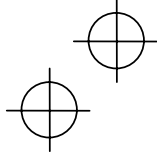

Figure 3.4 "Data Setting" Status Transition





Basic key operation

This section will give a description of the basic key operation, following the example of the function code data changing procedure shown in Figure 3.5.

This example shows you how to change function code F01 data from the factory default "Enable the built-in potentiometer (F01 = 4)" to "Enable the \triangleleft and \triangleright keys on the built-in keypad (F01 = 0)."

- (1) With the menu displayed, use the \triangleleft and \triangleright keys to select the desired function code group. (In this example, select 1.F_ _).
- (2) Press the FUNC CODE key to display the function codes in the function code group selected in (1). (In this example, function code F 00 will appear.)
Even if the function code list for a particular function code group is displayed, it is possible to transfer the display to a different function code group using the \triangleleft and \triangleright keys.
- (3) Select the desired function code using the \triangleleft and \triangleright keys and press the FUNC CODE key. (In this example, select function code F 01.)
The data of this function code will appear. (In this example, data 4 of F 01 will appear.)
- (4) Change the function code data using the \triangleleft and \triangleright keys. (In this example, press the \triangleright key four times to change data 4 to 0.)
- (5) Press the SAVE key to establish the function code data.
The *SAUE* will appear and the data will be saved in the non-volatile memory. The display will return to the function code list, then move to the next function code. (In this example, F 02.)
Pressing the FUNC CODE key before the SAVE key cancels the change made to the data. The data reverts to the previous value, the display returns to the function code list, and the original function code reappears.
- (6) Press the MENU key to return to the menu from the function code list.

Tip Cursor movement: You may move the cursor when changing function code data by holding down the FUNC CODE key for 1 second or longer in the same way as with the frequency settings. Refer to Section 3.3 (2) "Set up the Set Frequency and Others."

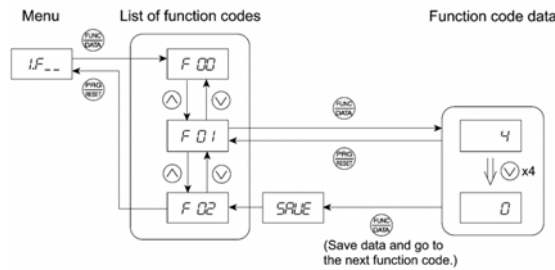
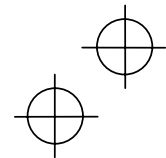
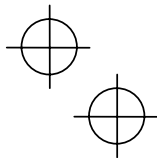
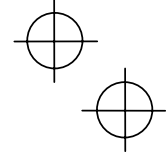
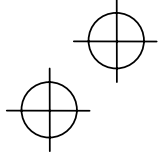

Figure 3.5 Example of Function Code Data Changing Procedure





3.5 Checking Changed Function Codes--"Data checking"

Menu #2 "Data checking" in Programming mode allows you to check function codes that have been changed. Only data that has been changed from the factory defaults are displayed on the LED monitor. You may refer to the function code data and change again if necessary. Figure 3.6 shows the status transition diagram for "Data checking."

To check function codes in Menu #2 "Data checking," it is necessary to set function code E52 data to 1 (Function code data check mode) or 2 (Full-menu mode).

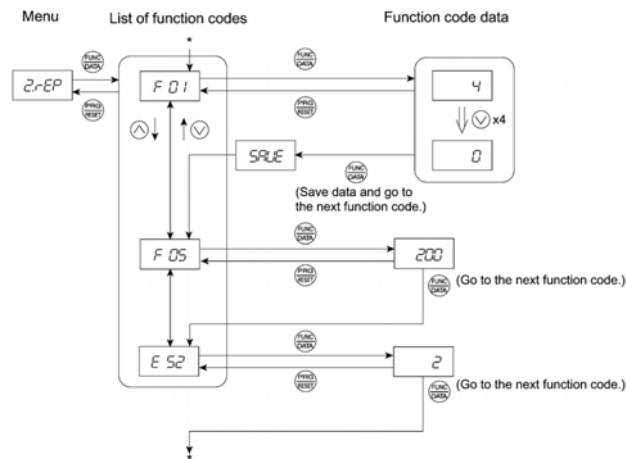

* Pressing the  key when the E 52 data is displayed will return to F 01.

Figure 3.6 "Data Checking" Status Transition (Changes made only to F01, F05, E52)

Basic key operation

The basic key operation is the same as for Menu #2 "Data setting."



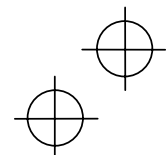
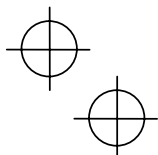
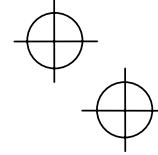
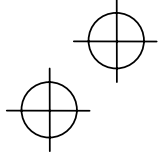

3.6 Monitoring the Running Status--"Drive monitoring"

Menu #3 "Drive monitoring" is used to check the running status during maintenance and test running. The display items for "Drive monitoring" are listed in Table 3.6. Using keys, you may check those items in succession. Figure 3.7 shows the status transition diagram for "Drive monitoring."
If you cannot switch the menu to any other one, set function code E52 data to 2 (Full-menu mode).

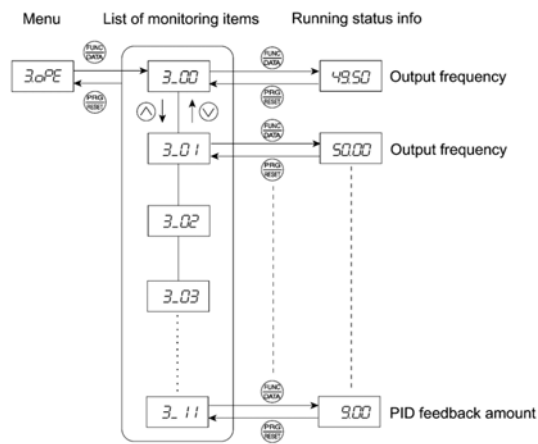

Figure 3.7 "Drive Monitoring" Status Transition

Basic key operation

- (1) With the menu displayed, use the and keys to select "Drive monitoring" (3.oPE).
- (2) Press the key to display the desired code in the monitoring items list (e.g. 3_00).
- (3) Use the and keys to select the desired monitoring item, then press the key.
The running status information for the selected item will appear.
- (4) Press the key to return to the monitoring items list. Press the key again to return to the menu.

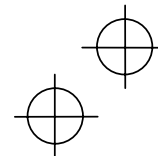
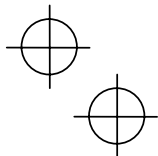
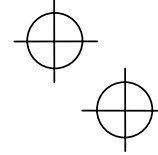
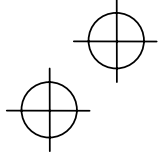

Table 3.6 Drive Monitoring Display Items

LED monitor shows:	Contents	Unit	Description
3_00	Output frequency	Hz	Output frequency before slip compensation
3_01	Output frequency	Hz	Output frequency after slip compensation
3_02	Output current	A	Output current
3_03	Output voltage	V	Output voltage
3_05	Set frequency	Hz	Set frequency
3_06	Running direction	N/A	Displays the running direction currently being outputted. F: forward; R: reverse, ---: stop
3_07	Running status	N/A	Displays the running status in hex. format. Refer to " Displaying running status " on the next page.
3_09	Load shaft speed (line speed)	rpm (m/min)	The unit for load shaft speed is rpm and that for line speed is m/min. Display value = (Output frequency Hz before slip compensation) × (Function code E50) └─┘ appears for 10000 (rpm or m/min) or more. When └─┘ appears, decrease function code E52 data so that the LED monitor displays 9999 or below, referring to the above equation.
3_10	PID process commands	N/A	These commands are displayed through the use of function code E40 and E41 data (PID display coefficients A and B). Display value = (PID process command) × (Factor A - B) + B If PID control is disabled, "----" appears.
3_11	PID feedback amount	N/A	This value is displayed through the use of function code E40 data and function code E41 data (PID display coefficients A and B). Display value = (PID feedback amount) × (PID display coefficient A - B) + B If PID control is disabled, "----" appears.



Displaying running status

To display the running status in hexadecimal format, each state has been assigned to bit 0 to 15 as listed in Table 3.7. Table 3.8 shows the relationship between each of the status assignments and the LED monitor display. Table 3.9 gives the conversion table from 4-bit binary to hexadecimal.

Table 3.7 Running Status Bit Allocation

Bit	Notation	Content	Bit	Notation	Content
15	BUSY	1 when function code data is being written.	7	VL	1 under voltage limiting control.
14	WR	Always 0.	6	TL	Always 0.
13		Always 0.	5	NUV	1 when the DC link circuit voltage is higher than the undervoltage level.
12	RL	1 when communication is effective (when run commands and set frequencies commands are issued via communications).	4	BRK	Always 0.
11	ALM	1 when an alarm has occurred.	3	INT	1 when the inverter output is stopped.
10	DEC	1 during deceleration.	2	EXT	1 during DC braking.
9	ACC	1 during acceleration.	1	REV	1 during running in the reverse direction.
8	IL	1 under current limiting control.	0	FWD	1 during running in the forward direction.

Table 3.8 Running Status Display

LED No.	LED4				LED3				LED2				LED1			
	15	14	13	12	11	10	9	8	7	6	5	4	3	2	1	0
Notation	BUSY	WR	RL	ALM	DEC	ACC	IL	VL	TL	NUV	BRK	INT	EXT	REV	FWD	
Binary	1	0	0	0	0	0	1	1	0	0	1	0	0	0	0	1
Example Hexa- decimal on the LED monitor																
	LED4				LED3				LED2				LED1			

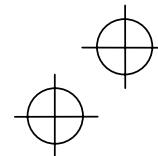
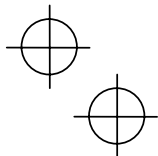

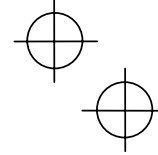
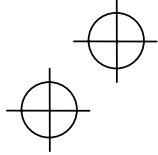

Hexadecimal expression

A 16-bit binary number is expressed in hexadecimal format (4 digits). Table 3.9 shows the expression. The hexadecimals are shown as they appear on the LED monitor.

Table 3.9 Binary and Hexadecimal Conversion

Binary				Hexadecimal	Binary				Hexadecimal
0	0	0	0	0	1	0	0	0	8
0	0	0	1	1	1	0	0	1	9
0	0	1	0	2	1	0	1	0	A
0	0	1	1	3	1	0	1	1	b
0	1	0	0	4	1	1	0	0	C
0	1	0	1	5	1	1	0	1	d
0	1	1	0	6	1	1	1	0	E
0	1	1	1	7	1	1	1	1	F

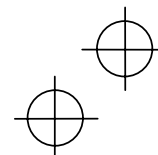
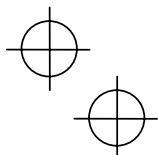

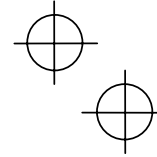
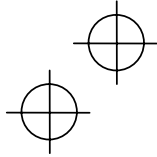

3.7 Checking I/O Signal Status--"I/O checking"

With Menu #4 "I/O checking," you may display the I/O status of external signals without using a measuring instrument. External signals that can be displayed include digital I/O signals and analogue I/O signals. Table 3.10 lists check items available. The status transition for I/O checking is shown in Figure 3.8.

If you cannot switch the menu to any other one, set function code E52 data to 2 (Full-menu mode).

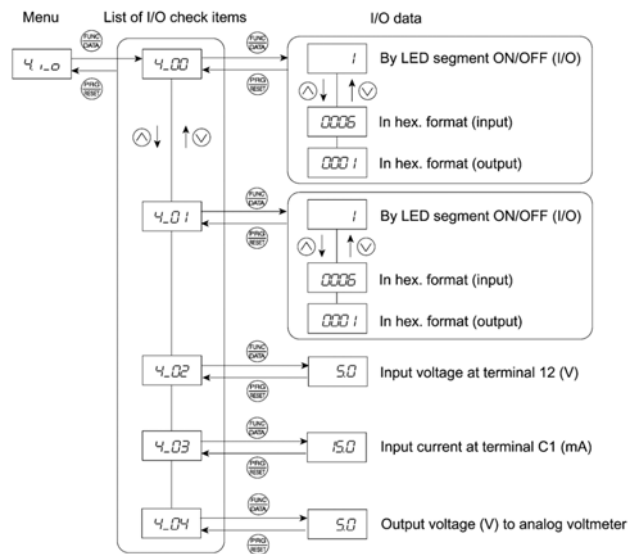
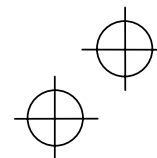
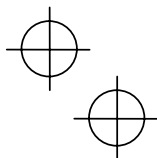

Figure 3.8 "I/O Checking" Status Transition

Basic key operation

- (1) With the menu displayed, use the **▲** and **▼** keys to select "I/O check"(4_1_0).
- (2) Press the **ENTER** key to display the codes for the I/O check item list. (e.g. 4_00)
- (3) Use the **▲** and **▼** keys to select the desired I/O check item, then press the **ENTER** key.
The corresponding I/O check data will appear. For control I/O signal terminal and control circuit terminal input under communication control, use the **▲** and **▼** keys to select one of the two different display methods.
- (4) Press the **ESC** key to return to the I/O check item list. Press the **ESC** key again to return to the menu.



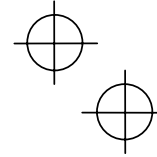
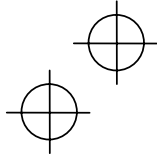

Table 3.10 I/O Check Items

LED monitor shows:	Display contents	Description
4_00	I/O signals on the control circuit terminals	Shows the ON/OFF state of the digital I/O terminals. Refer to " Displaying control I/O signal terminals " below for details on the display contents.
4_01	I/O signals on the control circuit terminals under communication control	Shows the ON/OFF state for the digital I/O terminals that received a command via RS485 communications. Refer to " Displaying control I/O signal terminals " below for details on the display contents.
4_02	Input voltage on terminal [12]	Shows the input voltage on terminal [12] in volts (V).
4_03	Input current on terminal [C1]	Shows the input current on terminal [C1] in milliamperes (mA).
4_04	Output voltage to analogue meters [FMA]	Shows the output voltage on terminal [FMA] in volts (V).

Displaying control I/O signal terminals

The status of control I/O signal terminal status may be displayed with ON/OFF of the LED segment or in hexadecimal display.

■ Display I/O signal status with ON/OFF of the LED Segment

As shown in Table 3.11 and the figure below, segments "a" to "e" on LED1 light when the digital input terminals ([FWD], [REV], [X1], [X2], and [X3]) are short-circuited with terminal [CM] and do not light when they are opened. Segment "a" on LED3 lights when the circuit between output terminal [Y1] and terminal [Y1E] is closed and does not light when the circuit is open. LED4 is for terminals [30A], [30B], [30C]. Segment "a" on LED4 lights when the circuit between terminals [30C] and [30A] are short-circuited (ON) and does not light when they are opened.

- Tip**
- If all terminal input signals are OFF (opened), segment "g" in all LEDs 1 to 4 will blink.
 - Refer to Chapter 5 "FUNCTION CODES" for details.

Table 3.11 Segment Display for External Signal Information

Segment	LED4	LED3	LED2	LED1
a	30ABC	Y1-Y1E	—	FWD-CM
b	—	—	—	REV-CM
c	—	—	—	X1-CM
d	—	—	—	X2-CM
e	—	—	—	X3-CM
f	—	—	(XF)*	—
g	—	—	(XR)*	—
dp	—	—	(RST)*	—

—: No correlating control circuit terminals

* (XF), (XR), and (RST) are assigned for communication. Refer to "**Displaying control I/O signal terminals under communication control**" given on the next page.

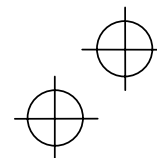
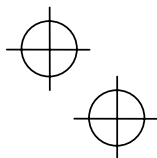
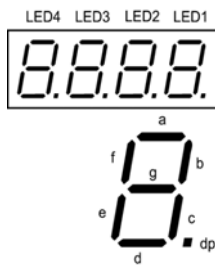

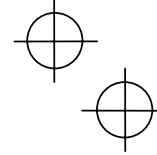
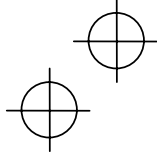

■ Displaying I/O signal status in hexadecimal format

Each I/O terminal is assigned to bit 15 through bit 0 as listed in Table 3.12. An unassigned bit is interpreted as "0." Allocated bit data is displayed on the LED monitor in 4-digit hexadecimal ("0" to "F" each).

With the Jaguar CUB, digital input terminals [FWD] and [REV] are assigned to bit 0 and bit 1, respectively. Terminals [X1] through [X3] are assigned to bits 2 through 4. The value "1" is set for each bit when the assigned input terminal is short-circuited with terminal [CM]. The value "0" when it opens. For example, when [FWD] and [X1] are on and all others are off, the display on LED4 to LED1 would be 0005.

The value "1" is set when bit 0 is assigned to digital output terminal [Y1] and the terminal is short-circuited with [Y1E], and the value "0" is set when it opens. The status of the mechanical relay contact output terminal [30A], [30B] and [30C] are assigned to bit 8. The value "1" is set when the circuit between output terminals [30A] and [30C] is closed and the value "0" when the circuit between [30B] and [30C] is closed. For example, if [Y1] is on and the circuit between [30A] and [30C] are short-circuited with each other, then the display for LED4 to LED1 would be 0101.

How the hexadecimal display is configured for the terminals to which bits 15 to 0 are assigned and the 7-segment LED is shown below.

Table 3.12 Segment Display for I/O Signal Status in Hexadecimal Format

LED No.	LED4				LED3				LED2				LED1			
Bit	15	14	13	12	11	10	9	8	7	6	5	4	3	2	1	0
Input terminal	(RST)*	(XR)*	(XF)*	-	-	-	-	-	-	-	-	X3	X2	X1	REV	FWD
Output terminal	-	-	-	-	-	-	-	30ABC	-	-	-	-	-	-	-	Y1
Binary	0	0	0	0	0	0	0	0	0	0	0	0	0	0	1	0
Example																

- : No correlating control connector

* (XF), (XR), and (RST) are assigned for communication. Refer to **"Displaying control I/O signal terminals under communication control."**

Displaying control I/O signal terminals under communication control

There are two control circuit input displays under communications link control – "display with ON/OFF of the LED segment" and "in hexadecimal format" for input commanded from RS485 communications link. The content is similar to that of the control I/O signal terminal status display; however, (XF), (XR), and (RST) are added as inputs. Under communications control, however, displaying I/O signal status supports only the normal logic system (that is ON-active).

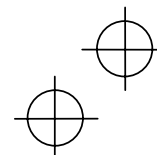
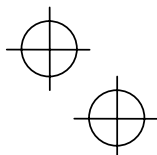

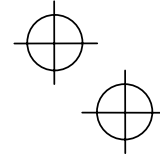
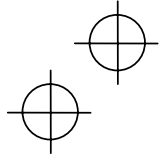

3.8 Reading Maintenance Information--"Maintenance information"

Menu #5 "Maintenance information" in Programming mode contains information necessary for performing maintenance on the inverter. Table 3.13 lists the maintenance information display items and Figure 3.9 shows the status transition for maintenance information.

If you cannot switch the menu to any other one, set function code E52 data to 2 (Full-menu mode).

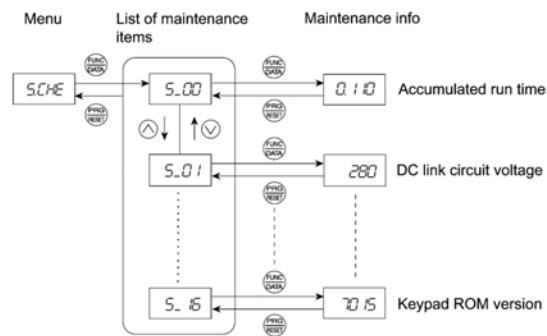

Figure 3.9 "Maintenance Information" Status Transition

Basic key operations

- (1) With the menu displayed, use the and keys to select "Maintenance information" (`5.CHE`).
- (2) Press the key to display the list of maintenance item codes (e.g. `5_00`).
- (3) Use the and keys to select the desired maintenance item, then press the key.
The data of the corresponding maintenance item will appear.
- (4) Press the key to return to the list of maintenance items. Press the key again to return to the menu.

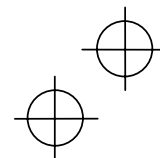
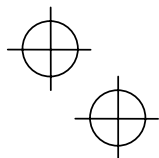
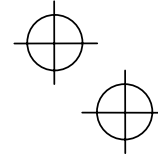
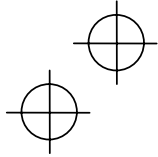

Table 3.13 Maintenance Display Items

LED Monitor shows:	Display contents	Description
5_00	Accumulated run time	Shows the accumulated power-ON time of the inverter. Unit: thousands of hours. When the total ON-time is less than 10,000 hours (display: 0.001 to 9.999), it is possible to check data in hourly units. When the total time is 10,000 hours or more (display: 10.00 to 65.53), the display will change to units of 10 hours. When the total time exceeds 65,535 hours, the display will be reset to 0 and the count will start again.
5_01	DC link circuit voltage	Shows the DC link circuit voltage of the inverter. Unit: V (volts)
5_03	Max. temperature of heat sink	Shows the maximum temperature of the heat sink for every hour. Unit: °C
5_04	Max. effective current	Shows the maximum effective current for every hour. Unit: A (amperes)
5_05	Capacitance of the DC bus capacitor	Shows the current capacitance of the DC bus capacitor, based on the capacitance when shipping as 100%. Refer to Chapter 7 "MAINTENANCE AND INSPECTION" for details. Unit: %
5_06	Accumulated run time of electrolytic capacitor on the printed circuit board	Shows the accumulated run time of the capacitor mounted on the printed circuit board. The display method is the same as for "accumulated run time" above. However, when the total time exceeds 65,535 hours, the count stops and the display remains at 65.53.
5_07	Accumulated run time of the cooling fan	Shows the accumulated run time of the cooling fan. The cooling fan ON/OFF control (function code H06) is effective, so the time when the fan is stopped is not counted. The display method is the same as for "accumulated run time" above. However, when the total time exceeds 65,535 hours, the count stops and the display remains at 65.53.
5_08	Number of startups	The motor run times (the number of times the inverter run command is set to on) are calculated and displayed. 1.000 indicates 1,000 times. When any number ranging from 0.001 to 9.999 is displayed, the display increases by 0.001 per startup, and when any number from 10.00 to 65.53 is displayed, the display increases by 0.01 every 10 startups. When the total number exceeds 65,535, the display will be reset to 0 and the count will start again.
5_11	No. of RS485 errors	Shows the total number of times RS485 communications error has occurred after the power is turned on. Once the number of errors exceeds 9.999, the display (count) returns to 0.
5_12	RS485 error contents	Shows the latest error that has occurred with RS485 communications in hexadecimal format.
5_14	ROM version of inverter	Shows the ROM version of the inverter as a 4-digit display.
5_16	ROM version of keypad panel	Shows the ROM version of the keypad panel as a 4-digit display. (For remote keypad only.)



3.9 Reading Alarm Information--"Alarm information"

Menu #6 "Alarm information" in Programming mode shows the cause of the past 4 alarms as alarm codes. Further, it is also possible to display alarm information that indicates the status of the inverter when the alarm occurred. Figure 3.10 shows the status transition of the alarm information and Table 3.14 lists the contents of the alarm information.

If you cannot switch the menu to any other one, set function code E52 data to 2 (Full-menu mode).

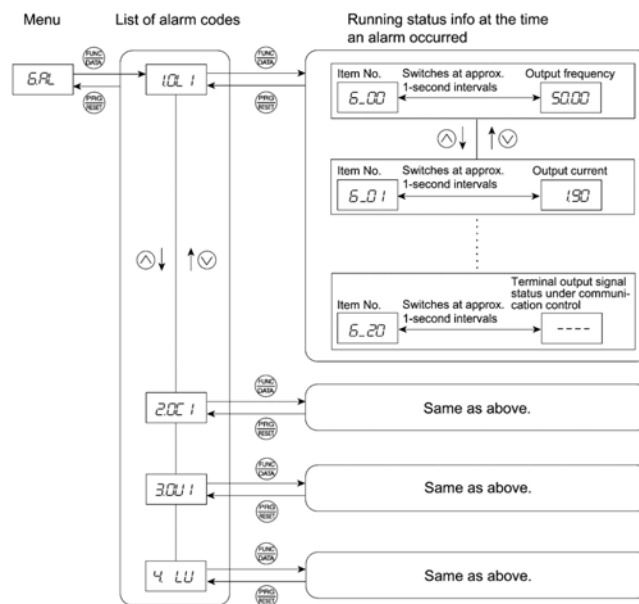

Figure 3.10 "Alarm Information" Status Transition

Basic key operations

- (1) With the menu displayed, use the \triangleleft and \triangleright keys to select "Alarm information" (6.AL).
- (2) Press the \rightarrow key to display the alarm list code (e.g. 1.OL1). In the list of alarm codes, the alarm information for last 4 alarms will be saved as an alarm history.
- (3) Each time the \triangleleft and \triangleright keys are pressed, the last four alarms are displayed in order from the most recent one as "1", "2", "3" and "4."
- (4) Press the \rightarrow key while the alarm code is displayed, and the corresponding alarm item number (e.g. 6_00) and data (e.g. Output frequency) are displayed continuously in turn for 1 second each. It is possible to display the item number (e.g. 6_01) and data (e.g. Output current) for each desired alarm using the \triangleleft and \triangleright keys.
- (5) Press the \rightarrow key to return to the alarm list. Press the \rightarrow key again to return to the menu.

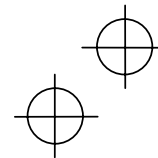
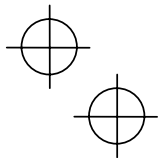

Table 3.14 Alarm Information Contents

LED monitor shows: (item No.)	Display contents	Description
6_00	Output frequency	Output frequency before slip compensation
6_01	Output current	Output current
6_02	Output voltage	Output voltage
6_04	Set frequency	Set frequency
6_05	Running direction	This shows the running direction being output. F: normal; R: reverse; ---: stop
6_06	Running status	This shows the running status as a hexadecimal display. Refer to Displaying running status in Section 3.6 "Monitoring the Running Status."
6_07	Accumulated running time	Shows the accumulated power-ON time of the inverter. Unit: thousands of hours. When the total ON time is less than 10,000 hours (display: 0.001 to 9.999), it is possible to check data in hourly units. When the total time is 10,000 hours or more (display: 10.00 to 65.53), the display will change to units of 10 hours. When the total time exceeds 65,535 hours, the display returns to 0 and the count will start again.
6_08	No. of startups	The motor run times (the number of times the inverter run command is set to on) are calculated and displayed. 1.000 indicates 1,000 times. When any number from 0.001 to 9.999 is displayed, the display increases by 0.001 per startup, and when any number from 10.00 to 65.53 is displayed, the display increases by 0.01 every 10 startups. When the total number exceeds 65,535, the display will be reset to 0 and the count will start again.
6_09	DC link circuit voltage	Shows the DC link circuit voltage of the inverter's main circuit. Unit: V (volts)
6_11	Max. temperature of heat sink	Shows the temperature of the heat sink. Unit: °C
6_12	Terminal I/O signal status (displayed with the ON/OFF of LED segments)	Shows the ON/OFF status of the digital I/O terminals. Refer to Displaying control I/O signal terminals in Section 3.7 "Checking I/O Signal Status" for details.
6_13	Signal input terminal status (in hexadecimal format)	
6_14	Terminal output signal status (in hexadecimal format)	
6_15	No. of consecutive occurrences	This is the number of times the same alarm occurs consecutively.
6_16	Overlapping alarm 1	Simultaneously occurring alarm codes (1) (--- is displayed if no alarms have occurred.)
6_17	Overlapping alarm 2	Simultaneously occurring alarm codes (2) (--- is displayed if no alarms have occurred.)

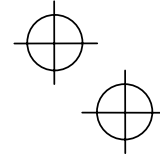
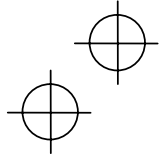
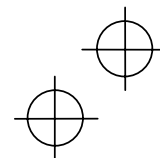
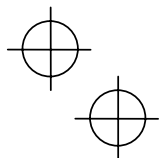

Table 3.14 Continued

LED monitor shows: (item No.)	Display contents	Description
6_18	Terminal I/O signal status under communication control (displayed with the ON/OFF of LED segments)	Shows the ON/OFF status of the digital I/O terminals under communication control. Refer to " Displaying control I/O signal terminals under communication control " in Section 3.7 "Checking I/O Signal Status" for details.
6_19	Terminal input signal status under communication control (in hexadecimal format)	
6_20	Terminal output signal status under communication control (in hexadecimal format)	

Note When the same alarm occurs a number of times in succession, the alarm information for the first time is retained and the information for the following alarms is not updated.



Chapter 4 RUNNING THE MOTOR

4.1 Running the motor for a test

4.1.1 Inspection and Preparation prior to the Operation

Check the following prior to starting the operation.

- (1) Check if connection is correct.

Especially check if the power wires are connected to inverter output terminals U, V and W and that the grounding wire is connected to the ground electrode correctly.

⚠ WARNING

- Do not connect power supply wires to the inverter output terminals U, V, and W. Otherwise, the inverter may be broken if you turn the power on.
- Be sure to connect the grounding wires of the inverter and the motor to the ground electrodes.

Otherwise, electric shock may occur.

- (2) Check for short circuits between terminals and exposed live parts and ground faults.
- (3) Check for loose terminals, connectors and screws.
- (4) Check if the motor is separated from mechanical equipment.
- (5) Turn the switches off so that the inverter does not start or operate erroneously at power-on.
- (6) Check if safety measures are taken against runaway of the system, e.g., a defense to protect people from unexpectedly approaching your power system.

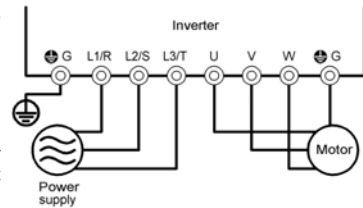

Figure 4.1 Connection of Main Circuit Terminals (Three-phase power supply)

4.1.2 Turning on Power and Checking

⚠ WARNING

- Be sure to install the terminal cover before turning the power on. Do not remove the cover during power application.
 - Do not operate switches with wet hands.
- Otherwise electric shock could occur.**

Turn the power on and check the following points. This is a case when no function code data is changed from the factory setting.

- (1) Check if the LED monitor displays "0.00" (means that the set frequency is 0 Hz) that is blinking. (See Figure 4.2)
If the LED monitor displays numbers except "0.00," then rotate the potentiometer to set "0.00" as the set frequency.
- (2) Check if a built-in cooling fan rotates (for models with 1.5 kW or more).



Figure 4.2 Display of the LED Monitor after Power-on

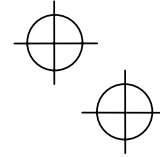
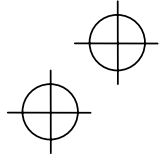

4.1.3 Preparation before running the motor for a test--Setting function code data

Before starting running the motor, set function code data specified in Table 4.1 to the motor ratings and your system design values. For the motor, check the rated values printed on the nameplate of the motor. For your system design values, ask system designers about them.

For details about how to change function code data, refer to Chapter 3, Section 3.4 "Setting the Function Codes." If the motor capacity is different from the inverter capacity, refer to Chapter 5, function code H03.

Table 4.1 Settings of Function Code Data before Driving the Motor for a Test

Function code	Name	Function code data	Factory setting
F 04	Base frequency	Motor ratings (printed on the nameplate of the motor)	60.0 (50.0) (Hz) (Note)
F 05	Rated Voltage (at base frequency)		0 (V) (Output voltage interlocked with the source voltage)
P 02	Motor Parameter (Rated capacity)		Applicable motor rated capacity
P 03	Motor Parameter (Rated current)		Rated current of applicable motor
P 99	Motor Selection		0: Characteristic of motor, 0 (standard 8-series motors)
F 03	Maximum frequency	System design values * For a test-driving of the motor, increase values so that they are longer than your system design values. If the set time is short, the inverter may not start running the motor.	60.0 (50.0) (Hz) (Note)
F 07	Acceleration time 1*		6.00 (sec)
F 08	Deceleration time 1*		6.00 (sec)

(Note) Values in parentheses () in the above table denote default settings for the EU version except three-phase 200 V series.

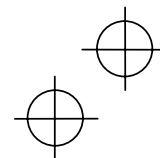
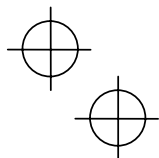

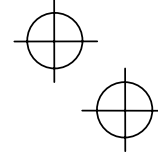
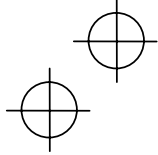

4.1.4 Test run

WARNING



If the user sets the function codes wrongly or without completely understanding this Instruction Manual, the motor may rotate with a torque or at a speed not permitted for the machine.
Accident or injury may result.

Follow the descriptions of the previous Section 4.1.1, "Inspection and Preparation prior to the Operation" to Section 4.1.3, "Preparation before running the motor for a test," and begin test-driving of the motor.

CAUTION

If any abnormality is found to the inverter or motor, immediately stop operation and determine the cause referring to Chapter 6, "TROUBLESHOOTING."

----- Procedure for Test Run -----

- (1) Turn the power on and check that the LED monitor blinks while indicating the 0.00 Hz frequency.
- (2) Rotate the built-in potentiometer clockwise, set the frequency to a low frequency such as 5 Hz. (Check that set frequency blinks on the LED monitor.)
- (3) Press the  key to start running the motor in the forward direction. (Check that the set frequency is displayed on the LED monitor correctly.)
- (4) To stop the motor, press the  key.

<Check the following points>

- Check if the direction of rotation is correct.
- Check for smooth rotation without motor humming or excessive vibration.
- Check for smooth acceleration and deceleration.

When no abnormality is found, rotate the potentiometer clockwise to raise the set frequency. Check the above points for the test-driving of the motor.

4.2 Operation

After checking that the operations finished correctly through the above test-driving, start normal operation.

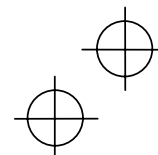
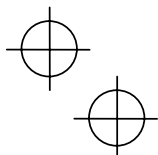

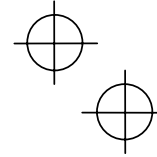
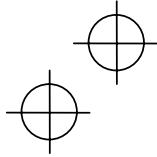

Chapter 5 FUNCTION CODES

5.1 Function Code Tables







Function codes enable the Jaguar CUB series of inverters to be set up to match your system requirements.

Each function code consists of a 3-letter string. The first letter is an alphabet that identifies its group and the following two letters are numerals that identify each individual code in the group. The function codes are classified into seven groups: Fundamental Functions (F codes), Extension Terminal Functions (E codes), Control Functions of Frequency (C codes), Motor Parameters (P codes), High Performance Functions (H codes), Application Functions (J codes), and Link Function (V codes). To determine the property of each function code, set data to the function code.

The following descriptions supplement those given in the function code tables on page 5-3 and subsequent pages.

■ Changing, validating, and saving function code data when the motor is running

Function codes are indicated by the following based on whether they can be changed or not when the inverter is running:

Notation	Change when running	Validating and saving function code data
Y*	Possible	If the data of the codes marked with Y* is changed, the change will immediately take effect; however, the change is not saved into the inverter's memory. To save the change, press the  key. If you press the  key without pressing the  key to exit the current state, then the changed data will be discarded and the previous data will take effect for the inverter operation.
Y	Possible	The data of the codes marked with Y can be changed with the  and  keys regardless of whether the motor is running or not. Pressing the  key will make the change effective and save it into the inverter's memory.
N	Impossible	—

■ Copying data

Connecting a remote keypad (option) to an inverter via the RS485 communications card (CUBRS485) allows copying the data stored in the inverter's memory into the keypad's memory (refer to Menu #7 "Data copying" in Programming mode). With this feature, you can easily transfer the data saved in a source inverter to other destination inverters.

If the specifications of the source and destination inverters differ, some code data may not be copied to ensure safe operation of your power system. Therefore, you need to set up the uncopied code data individually as necessary. Whether data will be copied or not is detailed with the following symbols in the "Data copy" column of the function code tables given below.

Y: Will be copied unconditionally.

Y1: Will not be copied if the rated capacity differs from the source inverter.

Y2: Will not be copied if the rated input voltage differs from the source inverter.

N: Will not be copied.

If necessary, manually set the function code data that cannot be copied.

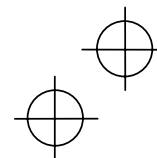
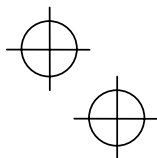

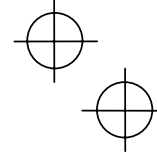
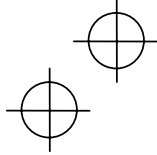

F10 to F12 Electronic Thermal Overload
(Motor property selection, Overload detection level, and Thermal time constant)

F10 through F12 set the thermal characteristics of the motor including the thermal time constant to simulate an overload status of the motor using the built-in electronic thermal processing function of the inverter. This function simulates the motor temperature based on the inverter's internally measured output current. F11 is used to determine the overload detection level.

Note Thermal characteristics of the motor specified by these function codes are also used for the overload early warning. Therefore, even if you need only the overload early warning, set these characteristics data to function codes F10 and F12.

F10 selects the cooling characteristics of the motor--built-in cooling fan or externally powered forced-ventilation fan.

Set F10 to:	If the motor is cooled by:
1	Built-in cooling fan for standard purpose motors (self-cooled) (The cooling performance will decrease with low frequency operations.)
2	Forced-ventilation fan powered by an inverter duty rated motor. (The cooling performance will be kept constant regardless of the output frequency.)

F11 sets the operation level of the electronic thermal function to the current value. Set approximately 1.0 to 1.1 multiples of the allowable continuous current (rated current of the motor) at the rated drive frequency (base frequency) of the motor under normal running conditions. To disable the electronic thermal function, set 0.00 to F11.

F12 sets the thermal time constant of the motor. The inverter interprets the time constant as an operation period of the electronic thermal function. During the specified operation period, the inverter will activate the electronic thermal function if 150% current of the operation level specified by F11 flows continuously. The time constant of general-purpose motors and other induction motors is set to 5 minutes by factory default.

Data entry range: 0.5 to 75.0 (minutes, in 0.1-minute increment)

F14 Restart Mode after Instantaneous Power Failure

Selects the action of the inverter to be followed when an instantaneous power failure occurs.

If the inverter detects that the DC link circuit voltage has dropped to less than the specified undervoltage limit during operation, it interprets the state as an occurrence of an instantaneous power failure. However, if the inverter runs with a light load and the period of the power failure is too short, then it may not detect the power failure and continue to run.

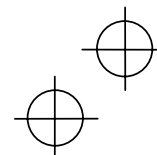
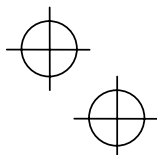

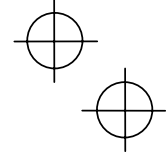
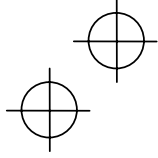

■ **Using negative logic for programmable I/O terminals**

The negative logic signaling system can be used for the digital input and output terminals by setting the function codes specifying the properties for those terminals. Negative logic refers to inverted ON/OFF (logical value 1 (true)/0 (false)) state of input or output signal. An ON-active signal (the function takes effect if the terminal is short-circuited.) in the normal logic system is functionally equivalent to OFF-active signal (the function takes effect if the terminal is opened.) in the negative logic system.

To set the negative logic system for an I/O signal terminal, display data of 1000s (by adding 1000 to the data for the normal logic) in the corresponding function code and then press the  key.

For example, if a coast-to-stop command (BX: data = 7) is assigned to any one of digital input terminals [X1] to [X3] by setting any of function codes E01 through E03, then turning (BX) on will make the motor coast to a stop. Similarly, if the coast-to-stop command (BX: data = 1007) is assigned, turning (BX) off will make the motor coast to a stop.

■ **Restriction on data displayed on the LED monitor**

Only four digits can be displayed on the 4-digit LED monitor. If you enter more than 4 digits of data valid for a function code, any digits after the 4th digit of the set data will not be displayed, however they will be processed correctly.

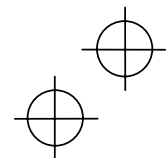
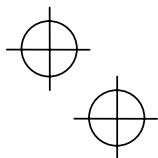

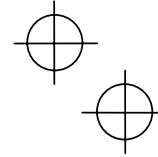
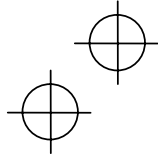

The following tables list the function codes available for the Jaguar CUB series of inverters.

F codes: Fundamental Functions

Code	Name	Data setting range	Incremental unit	Unit	Change when running	Data copy	Default setting	Refer to:
F00	Data Protection	0: Disable data protection (Function code data can be edited.) 1: Enable data protection (Function code data can not be edited.)	—	—	Y	N	0	5-13
F01	Frequency Command 1	0: Enable the and keys on the built-in keypad 1: Enable the voltage input to terminal [12] 2: Enable the current input to terminal [C1] 3: Enable the sum of voltage and current inputs to terminals [12] and [C1] 4: Enable the built-in potentiometer (POT)	—	—	N	Y	4	5-13
F02	Running/Stopping and Rotational Direction	0: Enable the and keys on the built-in keypad to run and stop motor (The (FWD) or (REV) command should be ON for forward or reverse rotation.) 1: Enable the external signal command (FWD) or (REV) command to run motor 2: Enable the and keys on the built-in keypad to run/stop motor forward 3: Enable the and keys on the built-in keypad to run/stop motor reverse	—	—	N	Y	2	5-14
F03	Maximum Frequency	25.0 to 400.0	0.1	Hz	N	Y	50.0	5-15
F04	Base Frequency	25.0 to 400.0	0.1	Hz	N	Y	50.0	5-15
F05	Rated Voltage (at base frequency)	0: Output voltage in line with variance in input voltage 80 to 240: Output voltage AVR-controlled (Note 1) 160 to 500: Output voltage AVR-controlled (Note 2)	1	V	N	Y2	0	5-15
F07	Acceleration Time 1	0.00 to 3600 Note: Acceleration time is ignored at 0.00. (External gradual acceleration pattern)	0.01	sec	Y	Y	6.00	—
F08	Deceleration Time 1	0.00 to 3600 Note: Deceleration time is ignored at 0.00. (External gradual deceleration pattern)	0.01	sec	Y	Y	6.00	—
F09	Torque Boost	0.0 to 20.0 (The set voltage at base frequency for F05 is 100 %.) Note: This setting is effective for auto torque boost/auto energy saving operations specified by function code F37 (= 0, 1, 3, or 4).	0.1	%	Y	Y	Standard torque boost*	5-17
F10	Electronic Thermal Overload for motor protection (Select the motor property)	1: For general-purpose motors with built-in self-cooled fans 2: For motors with forced-cooled fans	—	—	Y	Y	1	5-19
F11	(Overload detection level)	0.00 (Disabled) 1 to 135 % of rated current (allowable continuous load current) of the inverter	0.01	A	Y	Y1 Y2	Nominal** rated current of standard motor	5-19

*1 "Standard torque boost," "Nominal rated current of standard motor," and "Nominal rated capacity of standard motor" differ depending upon the rated input voltage and rated capacity. Refer to Table 5.1 "Standard Motor Parameters" on page 5-12.

(Note 1) For the three-phase 200 V and single-phase 200 V.

(Note 2) For the three-phase 400 V series

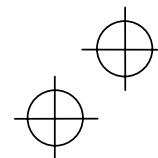
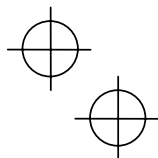

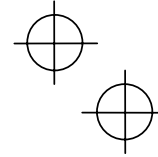
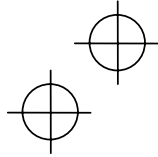

Code	Name	Data setting range	Incremental unit	Unit	Change when running	Data copy	Default setting	Refer to:
F12	(Thermal time constant)	0.5 to 75.0	0.1	min	Y	Y	5.0	5-19
F14	Restart Mode after Instantaneous Power Failure	0: Inactive (Trip immediately without restart) 1: Inactive (Trip without restart after recovery of power) 4: Active (Restart at the frequency at which the power failure occurred, for general load) 5: Active (Restart at the starting frequency, for low-inertia load)	—	—	Y	Y	0	5-19
F15	Frequency Limiter (Upper)	0.0 to 400.0	0.1	Hz	Y	Y	70.0	5-21
F16	(Lower)	0.0 to 400.0	0.1	Hz	Y	Y	0.0	5-21
F18	Bias (for Frequency Command 1)	-100.00 to 100.00	0.01	%	Y*	Y	0.00	5-22
F20	DC Braking (Starting frequency)	0.0 to 60.0	0.1	Hz	Y	Y	0.0	5-23
F21	(Braking level)	0 to 100 (Rated output current of the inverter interpreted as 100 %.)	1	%	Y	Y	0	5-23
F22	(Braking time)	0.00 (Disabled), 0.01 to 30.00	0.01	sec	Y	Y	0.00	5-23
F23	Starting Frequency	0.1 to 60.0	0.1	Hz	Y	Y	1.0	5-24
F25	Stop Frequency	0.1 to 60.0	0.1	Hz	Y	Y	0.2	5-24
F26	Motor Sound (Carrier frequency)	0.75 to 15	1	kHz	Y	Y	15	5-24
F27	(Sound tone)	0: Level 0 1: Level 1 2: Level 2 3: Level 3	—	—	Y	Y	0	5-24
F30	Terminal [FMA] (Gain to output voltage)	0 to 200 If 100 is set, +10 VDC will be output from [FMA] at full scale.	1	%	Y*	Y	100	5-25
F31	Analog Output Signal Selection for [FMA] (Monitor object)	0: Output frequency 1 (before slip compensation) Maximum frequency at full scale 1: Output frequency 2 (after slip compensation) Maximum frequency at full scale 2: Output current Two times the inverter's rated output current at full scale 3: Output voltage 250 V (500 V) at full scale 6: Input power Two times the inverter's rated output capacity at full scale 7: PID feedback amount Feedback amount is 100 % at full scale 9: DC link circuit voltage 500 VDC (for 200 V series), 1000 VDC (for 400 V series) at full scale 14: Test analog output (+) voltage If F30 = 100, +10 VDC at full scale	—	—	Y	Y	0	5-25

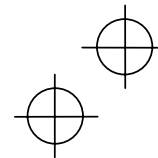
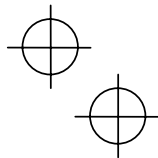

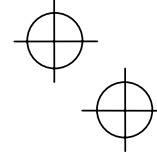
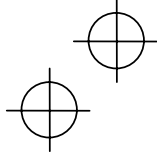

Code	Name	Data setting range	Incremental unit	Unit	Change when running	Data copy	Default setting	Refer to:
F37	Load Selection/ Auto Torque Boost/ Auto Energy Saving Operation	0: Torque reversely proportional to the square of speed 1: Constant torque load 2: Auto-torque boost 3: Auto-energy saving operation (Variable torque load during acceleration and deceleration) 4: Auto-energy saving operation (Constant torque load during acceleration and deceleration) 5: Auto-energy saving operation (Auto-torque boost during acceleration and deceleration)	—	—	N	Y	1	5-17
F43	Current Limiter (Operation condition)	0: Disabled 1: In constant speed (Disabled during acceleration and deceleration) 2: At acceleration and in constant speed (Disabled during deceleration)	—	—	Y	Y	0	5-27
F44	(Limiting level)	20 to 200 (The data is interpreted as the rated output current of the inverter for 100 %.)	1	%	Y	Y	200	5-27
F50	Electronic Thermal Overload Relay (for braking resistor) (Discharging capability)	0: (Not applicable) 1 to 900 999: (Disabled)	1	kWs	Y	Y	999	5-28
F51	(Allowable average loss)	0.000: Applied for built-in braking resistor, 0.001 to 50.000	0.001	kW	Y	Y	0.000	5-28

E codes: Extension Terminal Functions

Code	Name	Data setting range	Incremental unit	Unit	Change when running	Data copy	Default setting	Refer to:
E01	Terminal Command Assignment to: [X1]	To assign a negative logic input to a terminal, set the value of 1000s shown in () in the table below to the function code.	—	—	N	Y	0	5-30
E02	[X2]	0: (1000) Multi-step frequency selection (0 to 1 steps) (SS1)	—	—	N	Y	7	5-30
E03	[X3]	1: (1001) Multi-step frequency selection (0 to 3 steps) (SS2) 2: (1002) Multi-step frequency selection (0 to 7 steps) (SS4) 4: (1004) ACC/DEC time selection (2 steps) (RT1) 6: (1006) 3-wire operation stop command (HLD) 7: (1007) Coast-to-stop command (BX) 8: (1008) Alarm reset (RST) 9: (1009) Alarm from external equipment (THR) 10: (1010) Ready for jogging (JOG) 11: (1011) Frequency command 2 or 1 (Hz2/Hz1) 19: (1019) Enable editing of function codes from keypad (WE-KP) 20: (1020) Disable PID control (Hz/PID) 21: (1021) Switch normal/inverted driving (IVS) 24: (1024) Select link operation (RS485 communication, option) (LE) 33: (1033) Reset PID integral and differential components (PID-RST) 34: (1034) Hold PID integral component (PID-HLD)	—	—	N	Y	8	5-30

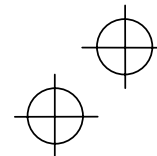
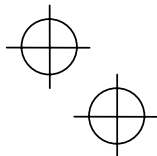

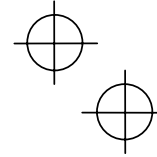
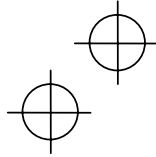

Code	Name	Data setting range	Incremental unit	Unit	Change when running	Data copy	Default setting	Refer to:
E10	Acceleration Time 2	0.00 to 3600	0.01	sec	Y	Y	6.00	—
E11	Deceleration Time 2	0.00 to 3600	0.01	sec	Y	Y	6.00	—
E20	Status Signal Assignment to: [Y1]	To assign a negative logic output to a terminal, set the value of 1000s shown in () on the table below to the function code. (OFF if short-circuited)	—	—	N	Y	0	5-34
E27	[30A, B, C] (Mechanical relay contacts)	0: (1000) Inverter running (RUN) 1: (1001) Frequency equivalence signal (FAR) 2: (1002) Frequency level detection (FDT) 3: (1003) Undervoltage detection signal (LU) 5: (1005) Torque limiting (Current limiting) (IOL) 6: (1006) Auto-restarting after recovery of power (IPF) 7: (1007) Motor overload early warning (OL) 26: (1026) Retry in operation (TRY) 30: (1030) Lifetime alarm (LIFE) 35: (1035) Inverter running (RUN2) 36: (1036) Overload prevention control (OLP) 37: (1037) Current detection (ID) 41: (1041) Low level current detection (IDL) 99: (1099) Alarm relay output (for any alarm) (ALM)	—	—	N	Y	99	5-34
E31	Frequency Detection (FDT) (Detection level)	0.0 to 400.0	0.1	Hz	Y	Y	50.0	—
E34	Overload Early Warning/Current Detection/Low Current Detection (Level)	0 (Disabled) Current value of 1 to 200 % of the rated inverter current	0.01	A	Y	Y1 Y2	Nominal*1 rated current of standard motor	—
E35	Current Detection/Low Current Detection (Timer)	0.01 to 600.00	0.01	sec	Y	Y	10.00	—
E39	Coefficient for Constant Feeding Rate Time	0.000 to 9.999	0.001	—	Y	Y	0.000	—
E40	PID Display Coefficient A	-999 to 0.00 to 999	0.01	—	Y	Y	100	—
E41	PID Display Coefficient B	-999 to 0.00 to 999	0.01	—	Y	Y	0.00	—
E43	Monitor Item Selection	0: Speed monitor (Select by E48.) 3: Output current 4: Output voltage 9: Input power 10: PID final command value 12: PID feedback amount 13: Timer value (Timer operation)	—	—	Y	Y	0	—
E45	(Note)							
E46								
E47								
E48	LED Monitor (Speed monitor item)	0: Output frequency before slip compensation 1: Output frequency after slip compensation 2: Set frequency 4: Load shaft speed in rpm 5: Line speed in m/min 6: Constant feeding rate time	—	—	Y	Y	0	—

(Note) Function codes E45 to E47 appear on the LED monitor; however, the Jaguar CUB series of inverters does not recognize these codes.

*1 "Standard torque boost," "Nominal rated current of standard motor," and "Nominal rated capacity of standard motor" differ depending upon the rated input voltage and rated capacity. Refer to Table 5.1 "Standard Motor Parameters" on page 5-12.

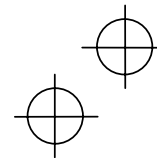
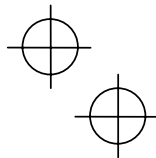

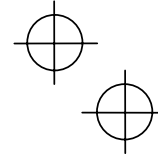
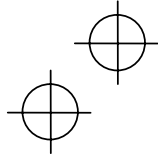

Code	Name	Data setting range	Incremental unit	Unit	Change when running	Data copy	Default setting	Refer to:
E50	Coefficient for Speed Indication	0.01 to 200.00	0.01	—	Y	Y	30.00	5-37
E52	Keypad (Menu display mode)	0: Function code data setting mode 1: Function code data check mode 2: Full-menu mode	—	—	Y	Y	0	—
E60	Built-in Potentiometer (Function selection)	0: None 1: Auxiliary frequency command 1 2: Auxiliary frequency command 2 3: PID process command 1	—	—	N	Y	0	—
E61	Analog Input Signal Definition for: [12]	0: None 1: Auxiliary frequency command 1	—	—	N	Y	0	—
E62	[C1]	2: Auxiliary frequency command 2 3: PID process command 1 5: PID feedback value	—	—	N	Y	0	—
E98	Terminal Command Assignment to: [FWD]	To assign a negative logic input to a terminal, set the value of 1000s shown in () in the table below to the function code.	—	—	N	Y	98	5-30
E99	[REV]	0: (1000) Multi-step frequency selection (0 to 1 steps) (SS1) 1: (1001) Multi-step frequency selection (0 to 3 steps) (SS2) 2: (1002) Multi-step frequency selection (0 to 7 steps) (SS4) 4: (1004) ACC/DEC time selection (2 steps) (RT1) 6: (1006) 3-wire operation stop command (HLD) 7: (1007) Coast-to-stop command (BX) 8: (1008) Alarm reset (RST) 9: (1009) Alarm from external equipment (THR) 10: (1010) Ready for jogging (JOG) 11: (1011) Frequency command 2 or 1 (Hz2/Hz1) 19: (1019) Enable editing of function codes from keypad (WE-KP) 20: (1020) Disable PID control (Hz/PID) 21: (1021) Switch normal/inverted driving (IVS) 24: (1024) Select link operation (RS485 communication, option) (LE) 33: (1033) Reset PID integral and differential components (PID-RST) 34: (1034) Hold PID integral component (PID-HLD) 98: Run forward command (FWD) 99: Run reverse command (REV)	—	—	N	Y	99	5-30

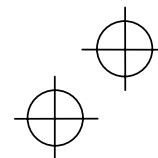
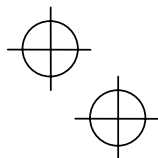

C codes: Control Functions of Frequency

Code	Name	Data setting range	Incremental unit	Unit	Change when running	Data copy	Default setting	Refer to:
C01	Jump Frequency 1	0.0 to 400.0	0.1	Hz	Y	Y	0.0	—
C02	2					Y	0.0	—
C03	3					Y	0.0	—
C04	Jump Frequency Band	0.0 to 30.0	0.1	Hz	Y	Y	3.0	—
C05	Multi-step Frequency Settings 1	0.00 to 400.00	0.01	Hz	Y	Y	0.00	—
C06	2					Y	0.00	—
C07	3					Y	0.00	—
C08	4					Y	0.00	—
C09	5					Y	0.00	—
C10	6					Y	0.00	—
C11	7					Y	0.00	—
C20	Jogging Frequency	0.00 to 400.00	0.01	Hz	Y	Y	0.00	—
C21	Timer Operation	0: Disable timer operation 1: Enable timer operation	—	—	N	Y	0	5-37
C30	Frequency Command 2	0: Enable the \curvearrowright and \curvearrowleft keys on the built-in keypad 1: Enable the voltage input to terminal [12] 2: Enable the current input to terminal [C1] 3: Enable the sum of voltage and current inputs to terminals [12] and [C1] 4: Enable the built-in potentiometer (POT)	—	—	N	Y	2	5-13
C32	Analog Input Adjustment (Gain for terminal input [12]) (Gain)	0.00 to 200.00	0.01	%	Y*	Y	100.0	5-22
C33	(Filter)	0.00 to 5.00	0.01	sec	Y	Y	0.05	—
C34	(Gain reference point)	0.00 to 100.00	0.01	%	Y*	Y	100.0	5-22
C37	Analog Input Adjustment (Gain for terminal input [C1]) (Gain)	0.00 to 200.00	0.01	%	Y*	Y	100.0	5-22
C38	(Filter)	0.00 to 5.00	0.01	sec	Y	Y	0.05	—
C39	(Gain reference point)	0.00 to 100.00	0.01	%	Y*	Y	100.0	5-22
C50	Bias (Frequency command 1) (Bias reference point)	0.00 to 100.00	0.01	%	Y*	Y	0.00	5-22
C51	Bias (PID command 1) (Bias value)	-100.00 to 100.00	0.01	%	Y*	Y	0.00	—
C52	(Bias reference point)	0.00 to 100.00	0.01	%	Y*	Y	0.00	—

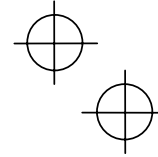
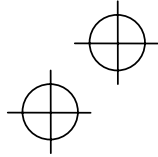

P codes: Motor Parameters

Code	Name	Data setting range	Incremental unit	Unit	Change when running	Data copy	Default setting	Refer to:
P02	Motor Parameters (Rated capacity)	0.01 to 10.00 kW (where, the data of function code P99 is 0, 3, or 4.)	0.01	kW	N	Y1	Nominal * rated capacity of standard motor	5-38
		0.01 to 10.00 HP (where, the data of function code P99 is 1.)	0.01	HP	N	Y2		
P03	(Rated current)	0.00 to 99.99	0.01	A	N	Y1 Y2	Nominal * rated current of standard motor	5-38
P09	(Slip compensation gain)	0.0 to 200.0 Typical rated slip frequency at 100%	0.1	%	Y*	Y	0.0	5-38
P99	Motor Selection	0: Standard motors 1: Typical motors rated in HP 3: Conventional motors 4: Other motors	—	—	N	Y1 Y2	0	5-39

H codes: High Performance Functions

Code	Name	Data setting range	Incremental unit	Unit	Change when running	Data copy	Default setting	Refer to:
H03	Data Initialization (Data reset)	0: Disable initialization 1: Initialize all function code data to the factory defaults 2: Initialize motor parameters	—	—	N	N	0	5-39
H04	Retry (No. of retries)	0: Inactive 1 to 10	1	Times	Y	Y	0	5-42
H05	(Waiting time)	0.5 to 20.0	0.1	sec	Y	Y	5.0	5-42
H06	Cooling Fan ON/OFF	0: Inactive 1: Active (1.5 kW or more)	—	—	Y	Y	0	—
H07	Gradual Acceleration/Deceleration	0: Inactive (Linear) 1: S-curve (Weak) 2: S-curve (Strong) 3: Curvilinear	—	—	Y	Y	0	5-43
H12	Instantaneous Overcurrent Limiting	0: Inactive 1: Active	—	—	Y	Y	1	5-44
H26	PTC Thermistor Input	0: Inactive 1: Active (PTC)	—	—	Y	Y	0	—
H27	(Level)	0.00 to 5.00	0.01	V	Y	Y	1.60	—
H30	Serial Link (Function selection)	Monitor Frequency command Run command 0: Y N N 1: Y RS485 N 2: Y N RS485 3: Y RS485 RS485 Y: Enable by inverter and via RS485 communication (option) RS485: Enable via RS485 communication (option) N: Enable by inverter	—	—	Y	Y	0	—
H42	Capacity of DC bus capacitor	For adjustment when replacing the capacitor	—	—	—	N	—	—
H43	Accumulated Run Time of Cooling Fan	For adjustment when replacing the cooling fan	—	—	—	N	—	—

* "Standard torque boost," "Nominal rated current of standard motor," and "Nominal rated capacity of standard motor" differ depending upon the rated input voltage and rated capacity. Refer to Table 5.1 "Standard Motor Parameters" on page 5-12.

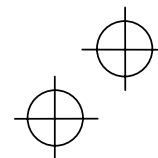
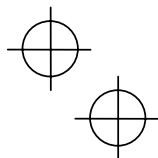

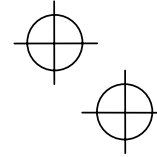
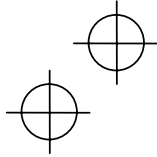

Code	Name	Data setting range	Incremental unit	Unit	Change when running	Data copy	Default setting	Refer to:
H50	Non-linear V/f Pattern (Frequency)	0.0 (Cancel), 0.1 to 400.0	0.1	Hz	N	Y	0.0	5-15
H51	(Voltage)	0 to 240: Output voltage AVR-controlled for 200 V class motors 0 to 500: Output voltage AVR-controlled for 400 V class motors	1	V	N	Y2	0	5-15
H54	ACC/DEC Time (Jogging operation)	0.00 to 3600	0.01	sec	Y	Y	6.00	—
H64	Bottom Limiter (Min. freq. when limiter is activated)	0.0 (Depends on F16 : Freq. limiter (bottom)), 0.1 to 60.0	0.1	Hz	Y	Y	2.0	—
H69	Automatic Deceleration	0: Inactive 1: Active	—	—	Y	Y	0	5-44
H70	Overload Prevention Control (Frequency drop rate)	0.00 (Equivalent to deceleration time), 0.01 to 100.00, 999 (Cancel)	0.01	Hz/s	Y	Y	999	5-45
H71	(Note)							
H80	Gain for Suppression of Output Current Fluctuation	0.00 to 0.20	0.01	—	Y	Y	0.20	—
H95	(Note)							
H96	STOP Key Priority/ Start Check Function	STOP key priority Start check function 0: Invalid Invalid 1: Valid Invalid 2: Invalid Valid 3: Valid Valid	—	—	Y	Y	0	5-45
H97	Clear Alarm Data	Returns to zero after clearing alarm data (if H97 = 1).	—	—	Y	N	—	—
H98	Protection/ Maintenance Function	opL: Invalid Invalid Invalid 1: Invalid Invalid Valid 2: Invalid Valid Invalid 3: Invalid Valid Valid 4: Valid Invalid Invalid 5: Valid Invalid Valid 6: Valid Valid Invalid 7: Valid Valid Valid opL: Output Phase Loss Protection Lin: Input Phase Loss Protection ADFCF: Automatic DEC Function for Carrier Frequency NOTE: For single-phase power input inverters, Lin is always invalid regardless of H98 setting.	—	—	Y	Y	3	5-46

(Note) Function codes H71 and H95 appear on the LED monitor; however, the Jaguar CUB series of inverters does not recognize these codes.

J codes: Application Functions

Code	Name	Data setting range	Incremental unit	Unit	Change when running	Data copy	Default setting	Refer to:
J01	PID Control	0: Inactive 1: Process control use (Normal action) 2: Process control use (Inverse action)	—	—	N	Y	0	—
J02	(Remote process command)	0: Keypad 1: PID process command 1 (Data settings of E60, E61 and E62 are also required.) 4: Communication	—	—	N	Y	0	—
J03	P (Gain)	0.000 to 10.000	0.001	Times	Y	Y	0.100	—
J04	I (Integration time)	0.0 to 3600.0	0.1	sec	Y	Y	0.0	—
J05	D (Differentiation time)	0.00 to 600.00	0.01	sec	Y	Y	0.00	—
J06	(Feedback filter)	0.0 to 900.0	0.1	sec	Y	Y	0.5	—

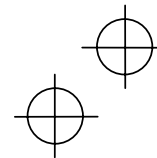
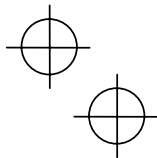

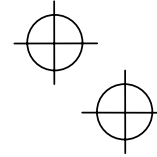
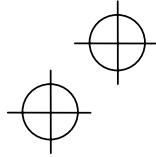

y codes: Link Functions

Code	Name	Data setting range	Incremental unit	Unit	Change when running	Data copy	Default setting	Refer to:
y01	RS485 Communication (Station address)	1 to 255	1	—	N	Y	1	—
y02	(Mode selection on no response error)	0: Immediate trip and alarm <i>Er-8</i> 1: Trip and alarm <i>Er-8</i> after running for the period of the timer set by y03 2: Retry during the period of the timer set by y03. If retry fails, trip and alarm <i>Er-8</i> 3: Continue to run	—	—	Y	Y	0	—
y03	(Timer)	0.0 to 60.0	0.1	sec	Y	Y	2.0	—
y04	(Baud rate)	0: 2400 bps 1: 4800 bps 2: 9600 bps 3: 19200 bps	—	—	Y	Y	3	—
y05	(Data length)	0: 8 bits 1: 7 bits	—	—	Y	Y	0	—
y06	(Parity check)	0: None 1: Even parity 2: Odd parity	—	—	Y	Y	0	—
y07	(Stop bits)	0: 2 bits 1: 1 bit	—	—	Y	Y	0	—
y08	(No response error detection time)	0 (No detection), 1 to 60	1	sec	Y	Y	0	—
y09	(Response interval)	0.00 to 1.00	0.01	sec	Y	Y	0.01	—
y10	(Protocol selection)	0: Modbus RTU protocol 1: SX protocol (Loader protocol) 2: General-purpose inverter protocol	—	—	Y	Y	1	—
y99	Link Function for Supporting Data Input	Frequency setting Run command 0: by H30 by H30 1: via RS485 communication (option) by H30 2: by H30 via RS485 communication (option) 3: via RS485 communication (option) via RS485 communication (option)	—	—	Y	N	0	—

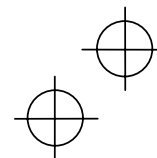
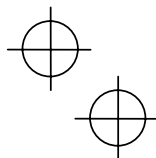

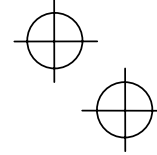
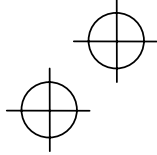

* The table below lists the factory settings of "standard torque boost," "Nominal rated current of standard motor," and "Nominal rated capacity of standard motor" in the "Default setting" column of the above tables.

Table 5.1 Standard Motor Parameters

Power supply voltage	Applicable motor rating (kW)	Standard value torque boost (%)	Nominal rated current of standard motor (A)	Nominal rated capacity of standard motor (kW)
		Function code F09	Function codes F11, E34 and P03	Function code P02
Three-phase 200 V	0.4	7.1	2.30	0.4
	0.75	6.8	3.60	0.75
Single-phase 200 V	1.5	6.8	6.10	1.5
	2.2	6.8	9.20	2.2
Three-phase 200 V	4.0	5.5	15.00	3.7
Three-phase 400 V	0.4	7.1	1.15	0.4
	0.75	6.8	1.80	0.75
	1.5	6.8	3.05	1.5
	2.2	6.8	4.60	2.2
	4.0	5.5	7.50	4.0

Note: When setting data to F11, E34 and P03, check the nameplate of the motor.

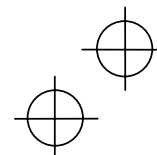
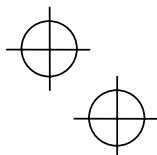

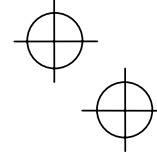
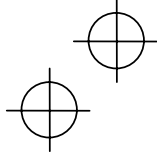

5.2 Overview of Function Codes

This section provides an overview of the function codes frequently used for the Jaguar CUB series of inverter.

F00	Data Protection
<p>Specifies whether function code data is to be protected from being accidentally changed by keypad operation. If data protection is enabled (F00 = 1), or key operation to change data is disabled so that no function code data, except F00 data, can be changed from the keypad. To change F00 data, simultaneous keying of + keys is required.</p>	

F01, C30	Frequency Command 1 and 2
<p>Selects the devices to set the set frequency 1 for driving the motor.</p>	
Set F01 to:	To do this
0	Enable the and keys on the built-in keypad. (Refer to Chapter 3 "OPERATION USING THE KEYPAD.")
1	Enable the voltage input to terminal [12] (0 to +10 VDC, maximum frequency obtained at +10 VDC).
2	Enable the current input to terminal [C1] (+4 to +20 mA DC, maximum frequency obtained at +20 mA DC).
3	Enable the sum of voltage and current inputs to terminals [12] and [C1]. See the two items listed above for the setting range and maximum frequencies. Note: If the sum exceeds the maximum frequency, the maximum frequency will apply.
4	Enable the built-in potentiometer (POT). (Maximum frequency obtained at full scale of the POT)

- Note**
- There are other frequency command means (such as the communications facility, multistep frequency, etc.) with higher priority than that of F01.
- Tip**
- For frequency commands by terminals [12] (voltage) and [C1] (current) and by the built-in potentiometer, setting the gain and bias changes the relationship between those frequency commands and the drive frequency to enable matching your system requirements. Refer to function code F18 for details.
 - For the inputs to terminals [12] (voltage) and [C1] (current), low-pass filters can be enabled. Refer to function codes C33 and C38 for details.

In addition to "F01 Frequency command 1," "C30: Frequency command 2" is also available. To switch them, use the terminal command (Hz2/Hz1). For details of the (Hz2/Hz1), refer to "E01 to E03: Command Assignment to Terminals [X1] to [X3]."

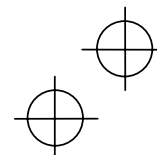
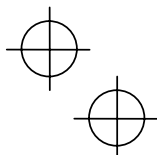

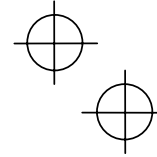
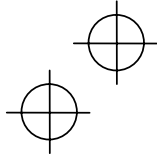

F02 Running/Stopping and Rotational Direction

Selects a source issuing a run command—keypad or external control signal input.

- If F02 = 0, 2, or 3, the inverter can run the motor by the and keys on the built-in keypad. The motor rotational direction can be specified in two ways, either by control signal input (F02 = 0) or by use of prefixed forward or reverse rotation (F02 = 2 or 3).

When F02 = 0, to specify the motor rotational direction by control signal input, assign the commands (FWD) and (REV) to terminals [FWD] and [REV], respectively. Turn on the (FWD) or (REV) for the forward or reverse direction, respectively, and then press the key to run the motor.

- If F02 = 1, the inverter can run the motor by control terminal inputs. To specify the motor rotational direction, assign the commands (FWD) and (REV) to terminals [FWD] and [REV], respectively. Turn on the (FWD) or (REV) for the forward or reverse direction, respectively. If both of (FWD) and (REV) are turned on simultaneously, the inverter immediately decelerates to stop the motor.

The table below lists the operational relationship between function code F02 (Running/Stopping and Rotational Direction), the key operation, and control signal inputs to terminals [FWD] and [REV], which determines the rotational direction.

Function code F02:	Key on the keypad	Control signal inputs to terminals [FWD] and [REV]		Motor rotational direction
		Function code E98 (FWD) command	Function code E99 (REV) command	
0	key	OFF	OFF	Stop
		ON	OFF	Forward
		OFF	ON	Reverse
		ON	ON	Stop
	key	OFF	OFF	Stop
		ON	OFF	
		OFF	ON	
		ON	ON	
1	Ignored.	OFF	OFF	Stop
		ON	OFF	Forward
		OFF	ON	Reverse
		ON	ON	Stop
2	key	Ignored.		Forward
	key			Stop
3	key	Ignored.		Reverse
	key			Stop

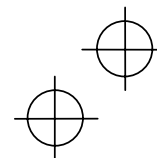
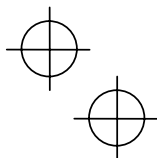

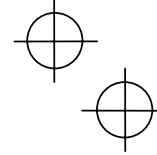
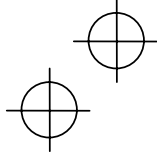

F03	Maximum Frequency
-----	-------------------

Sets the maximum frequency to drive the motor. Setting the frequency out of the range rated for the equipment driven by the inverter may cause damage or a dangerous situation. Set a maximum frequency appropriate for the equipment. For high-speed motors, it is recommended that the carrier frequency be set to 15 kHz.

CAUTION

The inverter can easily set high-speed operation. When changing the speed setting, carefully check the specifications of motors or equipment beforehand.
Otherwise injuries could occur.

F04	Base Frequency
F05	Rated Voltage (at Base Frequency)
H50	Non-linear V/f Pattern (Frequency)
H51	Non-linear V/f Pattern (Voltage)

These function codes set the base frequency and the voltage at the base frequency essentially required for running the motor properly. If combined with the related function codes H50 and H51, these function codes may set data needed to drive the motor along the non-linear V/f pattern.

The following description includes setting-up required for the non-linear V/f pattern.

■ Base frequency (F04)

Set the rated frequency printed on the nameplate located on the motor.

■ Rated voltage (at base frequency) (F05)

Set 0 or the rated voltage printed on the nameplate labeled on the motor.

- If 0 is set, the inverter supplies voltage equivalent to that of the power source of the inverter at the base frequency. In this case, the output voltage will vary in line with any variance in input voltage.

- If the data is set to anything other than 0, the inverter automatically keeps the output voltage constant in line with the setting. When any of the automatic torque boost settings, automatic energy saving or slip compensation is active, the voltage settings should be equal to the rating of the motor.

Note If F05 is set to match the rated voltage of the motor, motor efficiency will be better than that it is set to 0. Therefore, when brakes are applied to the motor, energy loss decreases and the motor regenerates larger braking energy, which can easily cause the overvoltage protection function (OU_n where $n=1$ to 3) to be activated. Note that the allowable power consumption capacity of the inverter for braking energy is limited by the specifications. If the overvoltage protection function is activated, it may be necessary to increase deceleration time or use an external braking resistor.

■ Non-linear V/f pattern for frequency (H50)

Sets the non-linear V/f pattern for frequency component.

(Setting 0.0 to H50 disables the non-linear V/f pattern operation.)

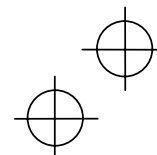
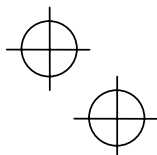

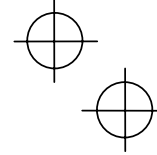
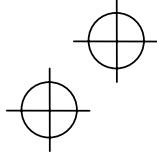

■ Non-linear V/f pattern for voltage (H51)

Sets the non-linear V/f pattern for voltage component.

If the rated voltage at base frequency (F05) is set to 0, the data settings of function codes H50 and H51 will be ignored.

Note If you set the data of H50 to 25 Hz or lower (Operation under low base frequency), the inverter output voltage may be limited.

Defining non-linear V/f patterns (F04, F05, H50 and H51)

Function codes F04 and F05 define a non-linear V/f pattern that forms the relationship between the inverter's output frequency and voltage.

Furthermore, setting the non-linear V/f pattern using function codes H50 and H51 allows patterns with higher or lower voltage than that of the normal pattern to be defined at an arbitrary point inside or outside the base frequency. Generally, when a motor is driven at a high speed, its internal impedance may increase and output torque may decrease due to the decreased drive voltage. This feature helps you solve that problem. Note that setting the voltage in excess of the inverter's input source voltage is not allowed.

■ Normal (linear) V/f pattern

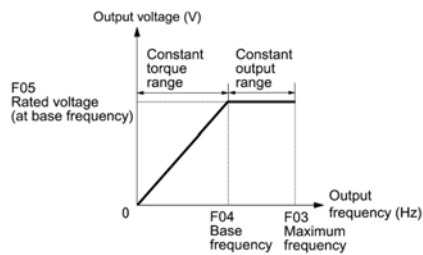

■ V/f pattern with single non-linear point inside the base frequency

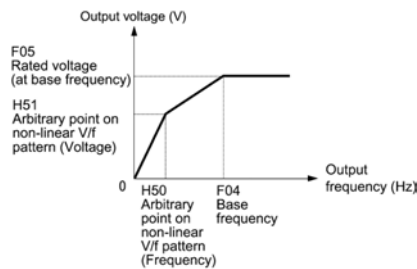

Tip You can also set the optional non-linear V/f range (H50: Frequency) for frequencies exceeding the base frequency (F40).

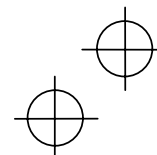
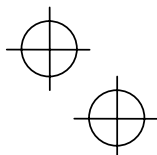

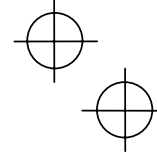
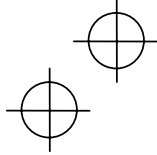

F09 F37	Torque Boost Load Selection/Auto Torque Boost/Auto Energy Saving Operation
------------	---

In general, there are two different properties of loads—the torque load which is inversely proportional to the square of speed (fans and pumps) and the constant torque load (industrial machinery). You can select a V/f pattern optimized to the load property.

Manual torque boost

In manual torque boost mode, the inverter maintains the output at a constant level regardless of the load. When you use this mode, select the appropriate V/f pattern (square reduction torque or constant torque characteristics) with Select Load (F37). To keep the motor starting torque, manually select optimal inverter output voltage for the motor and load by setting an optimal torque boost rate to F09 in accordance with the motor and its load.

Setting an excessive torque boost rate may result in over-excitation and overheat of the motor during light or no load operation.

Manual torque boost keeps the output voltage constant even if the load varies, assuring stable motor operation.

Variable torque characteristics (F37 = 0)

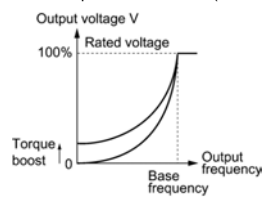

Constant torque characteristics (F37 = 1)

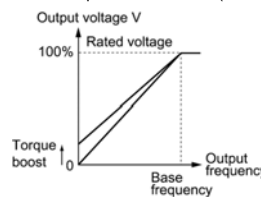

- Note**
- Set an appropriate torque boost rate that will keep the starting torque of the motor within the voltage level in the low frequency zone. Setting an excessive torque boost rate may result in over-excitation or over-heat of the motor during no load operation.
 - The F09 data setting is effective when F37 (Load Selection/Auto Torque Boost/Auto Energy Saving Operation) is set to 0, 1, 3, or 4.

Automatic torque boost

This feature automatically optimizes the output voltage to fit the motor and its load. Under a light load, it decreases the output voltage to prevent the motor from over-excitation; under a heavy load, it increases the output voltage to increase torque.

Since this feature is related to the motor properties, it is necessary to set the rated voltage at base frequency (F05) and motor parameters (P codes) properly.

- Note**
- For the automatic torque boost feature, which is related to the motor characteristics, you need to consistently set the voltage at the base frequency (F05) and motor parameters P02, P03 and P99 appropriately for the motor rating and characteristics.

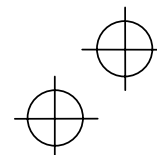
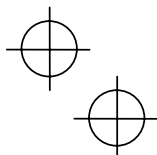

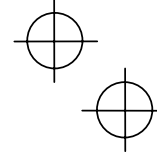
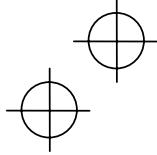

Auto energy saving operation

This feature controls the terminal voltage of the motor automatically to minimize the motor power loss. (Note that this feature may not be effective depending upon the motor characteristics. Check the characteristics before using this feature.)

The inverter enables this feature for constant speed operation only. During acceleration and deceleration, the inverter will run with manual or automatic torque boost, depending on function code F37. If auto energy saving operation is enabled, the response to a change in motor speed may be slow. Do not use this feature for a system that requires quick acceleration and deceleration.

Note When the base frequency is 60 Hz or lower, use the auto energy saving operation. If it is higher than 60 Hz, the decreased or no effect of the auto energy saving operation may be brought about.

The auto energy saving operation is designed for use with the frequency lower than the base frequency. If the frequency becomes higher than the base frequency, the auto energy saving operation will be invalid.

For the auto energy saving function, which is related to the motor characteristics, you need to consistently set the voltage at the base frequency (F05) and motor parameters P02, P03 and P99 appropriately for the motor rating and characteristics.

Given below are proper setting examples with the combination of F09 and F37.

- If you do not select auto energy saving operation

Load type	To select manual torque boost, set:	To select automatic torque boost, set:
Variable torque	F37 = 0 F09 = 0.0 to 20.0 (%)	F37 = 2
Constant torque	F37 = 1 F09 = 0.0 to 20.0 (%)	

- If you select auto energy saving operation

Load type	To select manual torque boost, set:	To select automatic torque boost, set:
Variable torque	F37 = 3 F09 = 0.0 to 20.0 (%)	F37 = 5
Constant torque	F37 = 4 F09 = 0.0 to 20.0 (%)	

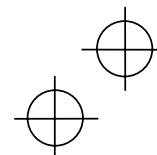
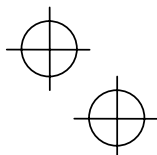

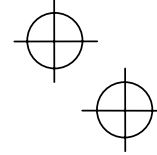
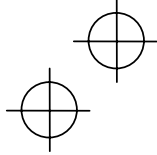

- Trip immediately (F14 = 0)

If an instantaneous power failure occurs when the inverter is in Running mode so that the inverter detects undervoltage of the DC link circuit, then the inverter immediately stops its output and displays the undervoltage alarm "LU" on the LED monitor. The motor will coast to a stop and the inverter will not restart automatically.

- Trip after recovery of power (F14 = 1)

If an instantaneous power failure occurs when the inverter is in Running mode, causing the inverter to detect undervoltage of the DC link circuit, the inverter immediately stops its output without transferring to Alarm mode or displaying the undervoltage alarm "LU". The motor will coast to a stop. When the power is recovered, the inverter will enter Alarm mode for undervoltage.

- Restart at the frequency at which the power failure occurred (F14 = 4)

If an instantaneous power failure occurs when the inverter is in Running mode so that the inverter detects undervoltage of the DC link circuit, then the inverter saves the current output frequency and stops its output to make the motor to coast to a stop. When the power is recovered with any run command being on, the inverter will restart at the saved frequency.

During the instantaneous power failure, if the motor speed slows down, the current limiter function of the inverter will be activated and automatically lower the output frequency. Upon synchronization of the output frequency and motor speed, the inverter accelerates up to the previous output frequency. Refer to the figure (F14 = 4) given below for details.

To synchronize the output frequency and motor speed, however, the momentary overcurrent limiter (H12 = 1) should be enabled.

This setting is optimal for operations in which the motor speed rarely slows down due to the heavy moment of inertia of its load even if the motor coasts to a stop because of the instantaneous power failure.

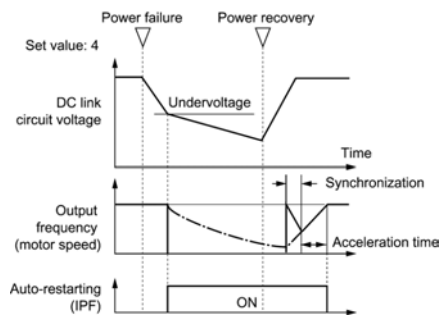

- Restart at the starting frequency (F14 = 5)

If an instantaneous power failure occurs when the inverter is in Running mode so that the inverter detects undervoltage of the DC link circuit, then the inverter immediately stops its output. After the power is recovered, entry of any run command will restart the inverter at the frequency specified by function code F23.

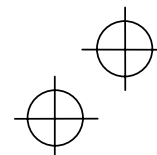
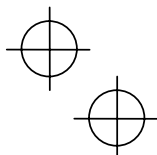

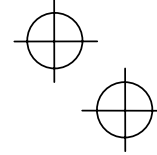
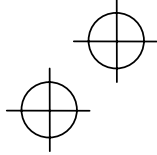

This setting is optimal for operations in which the motor speed quickly slows down to 0 rpm due to the heavy load with a very small moment of inertia if the motor coasts to a stop because of the instantaneous power failure.



- There is a 0.5-second delay from detection of the undervoltage until the motor is restarted. This delay is due to the time required for the residual electricity (magnetic flux) in the motor to drop sufficiently. Therefore, even if the instantaneous power failure period is shorter than 0.5 second, a delay of at least 0.5 second is required for the motor to restart.
- When an instantaneous power failure occurs, the power supply voltage for external circuitry (such as relay circuits) that controls the inverter may also drop to the extent that run commands are disabled. Therefore, have the system wait 2 seconds before the issue of run commands. If any run command is issued within 2 seconds, however, the inverter will restart. If it is after 2 seconds, the inverter will start at the starting frequency preset by the related function codes. The external circuitry should be configured so that it is able to issue any run command within 2 seconds, or so that it features a mechanical latch relay mechanism that ensures the safety of the system in the event of an instantaneous power failure.
- If a coast-to-stop command (BX) is issued during the time from the detection of an instantaneous power failure to repowering, the inverter exits from the state of waiting for restarting, and enters Running mode. If any run command is issued, the inverter will start at the starting frequency preset.

WARNING

If you select restart after instantaneous power failure (F14 = 4 or 5), the inverter will automatically restart running the motor when the power is recovered. The machine should be so designed that human body and peripheral equipment safety is ensured even after automatic restarting.

Otherwise an accident could occur.

F15, F16 Frequency Limiter (Upper and Lower)

Frequency limiter F15 limits the upper limiter of output frequency. Frequency limiter F16 maintains the output frequency at the lower limiter even if the set frequency is lower than the lower limiter. Refer to the figure below.

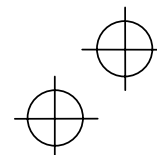
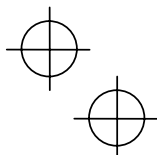
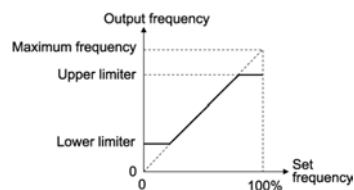

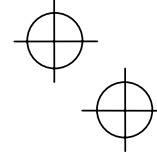
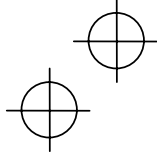

Note Set the upper and lower frequencies correctly; otherwise, the inverter may not operate. Maintain the following relationship:
 (Upper frequency) > (Lower frequency), (Starting frequency), (Stop frequency)
 (Lower frequency) < (Maximum frequency)

F18	Bias (for Frequency Command 1)
C50	Bias (Bias reference point for frequency command 1)
C32, C34	Analogue Input Adjustment (Gain and gain reference point for terminal input [12])
C37, C39	Analogue Input Adjustment (Gain and gain reference point for terminal input [C1])

If you select any analogue input for frequency command 1 (set by F01), you can define the relationship between the analogue input and the set frequency arbitrarily by combining the settings for bias (F18), bias reference point (C50), gains (C32 and C37), and gain reference points (C34 and C39).

As illustrated in the graph below, the relationship between the set frequency and analogue input level for frequency command 1 is shown by a straight line passing through points "A" and "B." The point "A" is determined by the bias command (F18) and its reference point (C50). The "B" is determined by the gain commands (C32 or C37) and its reference point (C34 or C39). The combination of C32 and C34 will apply for terminal [12] and that of C37 and C39 for terminal [C1].

The bias (F18) and gain (C32 or C37) should be set, assuming the maximum frequency as 100%. The bias reference point (C50) and gain frequency point (C34 or C39) should be set, assuming the full scale (+10 VDC or +20 mA) as 100%.

Note Analogue input under the bias reference point is limited by the bias data.

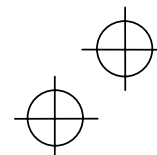
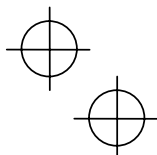
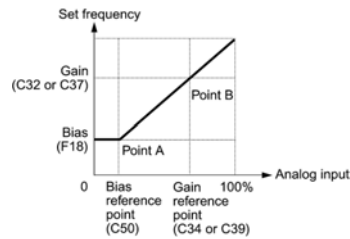

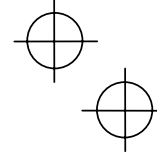
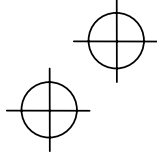

The relations stated above are indicated in the following expressions.

(1) If analogue input \leq bias reference point:

$$\text{Frequency Setting 1 (\%)} = \text{Bias (F18)}$$

(2) If analogue input $>$ bias reference point:

Frequency Setting 1 (%)

$$\begin{aligned} &= \frac{(\text{Gain}) - (\text{Bias})}{(\text{Gain reference point}) - (\text{Bias reference point})} \times \text{Analogue input} \\ &+ \frac{(\text{Bias}) \times (\text{Gain reference point}) - (\text{Gain}) \times (\text{Bias reference point})}{(\text{Gain reference point}) - (\text{Bias reference point})} \\ &= \frac{\text{C32} - \text{F18}}{\text{C34} - \text{C50}} \times \text{Analogue input} + \frac{\text{F18} \times \text{C34} - \text{C32} \times \text{C50}}{\text{C34} - \text{C50}} \end{aligned}$$

In the above expressions, each function code expresses its data.

Example: Setting the bias, gain and its reference point when analogue input range from +1 to +5 VDC is selected for frequency command 1

(Point A)

If the analogue input is at 1 V, the set frequency is 0 Hz. Therefore, the bias is 0% (F18 = 0). Since 1 V is the bias reference point and it is equal to 10% of 10 V, then the bias reference point should be 10% (C50 = 10).

(Point B)

If the analogue input is at 5 V, the set frequency comes to be the maximum value. Therefore, the gain is 100% (C32 = 100). Since 5 V is the gain reference point and it is equal to 50% of 10 V, then the gain reference point should be 50% (C34 = 50).

Note When using the function codes for setting a gain or bias alone without changing any reference points, the setting procedure for the function codes is the same as that of IMO's conventional inverter models.

F20 to F22 DC Braking (Starting frequency, Braking level, and Braking time)

These function codes enable the DC braking to prevent the motor from coasting due to its inertia while it is decelerating to a stop. Set function codes F20 for the starting frequency, F21 for the braking level, and F22 for the braking time.

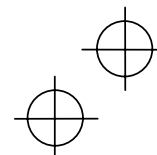
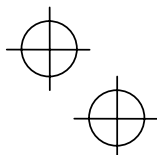

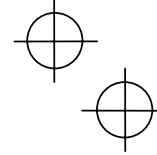
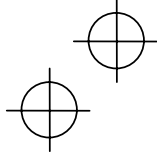

Note For three-phase 200V and single-phase 200V series inverters

The braking level setting for the three-phase 200V and single-phase 200V series should be calculated from the DC braking level I_{DB} (A) based on the reference current I_{ref} (A), as shown below.

$$\text{Setting (\%)} = \frac{I_{DB} \text{ (A)}}{I_{ref} \text{ (A)}} \times 100$$

(Example) Setting the braking level I_{DB} at 4.2 Amp (A) for 0.75 kW standard motors

$$\text{Setting (\%)} = \frac{4.2 \text{ (A)}}{5.0 \text{ (A)}} \times 100 = 84$$

Applicable motor rating (kW)	N/A	N/A	0.4	0.75	1.5	2.2	4.0
Reference current I_{ref} (A)	N/A	N/A	3.0	5.0	8.0	11.0	17.0

CAUTION

The brake function of the inverter does not provide mechanical holding means. **Otherwise injuries could occur.**

F23, F25 Starting Frequency and Stop Frequency

At the startup of an inverter, the initial output frequency is equal to the starting frequency. The inverter stops its output at the stop frequency.

Set the starting frequency to a level that will enable the motor to generate enough torque for startup. Generally, set the motor's rated slip frequency to F23.

Note If the starting frequency is lower than the stop frequency, the inverter will not output any power as long as the set frequency does not exceed the stop frequency.

F26, F27 Motor Sound (Carrier frequency and Tone)

■ Motor Sound (Carrier frequency) (F26)

Changing the carrier frequency may decrease the motor running noise, leakage current from the output lines, and electric noise from the inverter.

Carrier frequency	0.75 → 15 kHz
Motor running noise	Noisy → quiet
Output current waveform	Poor → good
Leakage current level	Low → high
Electric noise level	Low → high

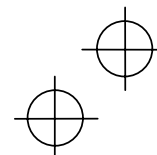
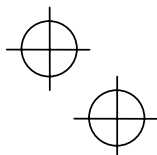

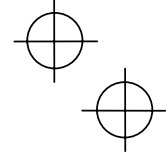
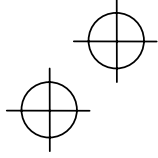

Note Lowering the carrier frequency increases the ripple components (harmonic components) on the output current waveform so as to increase the motor's power loss and raises the temperature of the motor. If the carrier frequency is set at 0.75 kHz, for example, estimate the motor output torque at 85% or less of the rated motor torque.

On the contrary, raising the carrier frequency increases the inverter's power loss and raises the temperature of the inverter. The inverter has a built-in overload protection function that automatically decreases the carrier frequency to protect the inverter. For details about the function, refer to function code H98.

■ Motor Sound (Tone) (F27)

Changes the motor running sound tone. This setting is effective when the carrier frequencies set to function code F26 is 7 kHz or lower. Changing the tone level may reduce the high and harsh running noise from the motor.

F30	Terminal [FMA] (Gain to output voltage)
F31	Analogue Output Signal Selection for [FMA] (Monitor object)

F31 allows you to output monitored data (such as the output frequency or output current) to terminal [FMA] as an analogue DC voltage that can be adjusted with F30 for the meter scale.

■ Adjusting the output voltage level (F30)

Adjust the output voltage level within the range of 0 to 200%, supposing the monitored amount of the monitor selected with function code F31 as 100%.

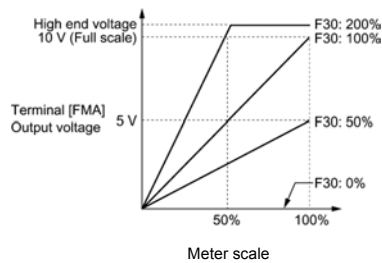

■ Selecting object to be monitored (F31)

Select the output to terminal [FMA] for monitoring.

Note In the case of the CUB9A-4□**, the actual output level will be multiplied by 108% as the reference motor rating is 3.7 kW.

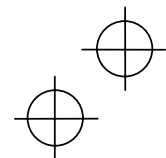
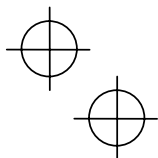

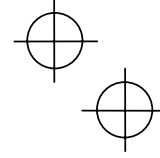
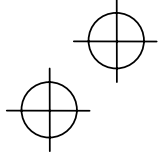

Note For three-phase 200V and single-phase 200V series of inverters

Outputting the output current in an analogue format (FMA) (F31 = 2)

The analogue output terminal [FMA] outputs 10 V, that is, 200% of the reference current I_{ref} (A), supposing the output gain selected with F30 as 100%. For three-phase 200V and single-phase 200V series, therefore, you need to set the output gain (F30) based on the conversion result obtained by the following expression:

- Conversion expression for calculating the output gain which is required for outputting the voltage V (V) via terminal [FMA] when current I (A) flows across the inverter

$$\text{Output gain} = 2 \times \frac{I_{ref} \text{ (A)}}{I \text{ (A)}} \times \frac{V \text{ (V)}}{10 \text{ (V)}} \times 100$$

I_{ref} (A): Reference current (A)

 The reference current is given in the table for F20 to F22 on page 5-24.

According to the conversion result, the output voltage to terminal [FMA] can be calculated as shown below.

$$\text{Analogue output voltage (V)} = \frac{I \text{ (A)}}{2 \times I_{ref} \text{ (A)}} \times \frac{\text{Output gain (F30)}}{100} \times 10 \text{ (V)}$$

(Example) Outputting analogue voltage 8V for 0.75 kW standard motors when the inverter output current is 4.2A

$$\text{Output gain} = 2 \times \frac{5.0 \text{ (A)}}{4.2 \text{ (A)}} \times \frac{8 \text{ (V)}}{10 \text{ (V)}} \times 100 = 190.4$$

$$\text{Analogue output voltage (V)} = \frac{4.2 \text{ (A)}}{2 \times 5.0 \text{ (A)}} \times \frac{190}{100} \times 10 \text{ (V)} = 7.98$$

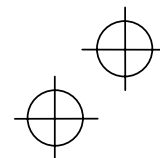
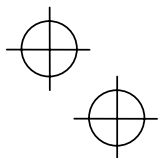

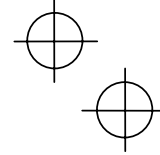
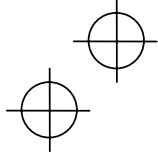

F43, F44 Current Limiter (Operation condition and Limiting level)

F43 enables or disables the current limiter. If it is enabled, the inverter controls the output frequency while keeping the current set to F44 in order to prevent the motor from stalling.

With F43, you may select whether the current limiter works during constant speed operation only (F43 = 1) or during both acceleration and constant speed operation (F43 = 2). Set F43 to 1, for example, to drive the motor at maximum performance in the acceleration zone and to limit the drive current in the constant speed zone.

Note For three-phase 200V and single-phase 200V series inverters
The limiting level setting for the three-phase 200V and single-phase 200V series should be calculated from the current limiting level I_{limit} (A) based on the reference current I_{ref} (A), as shown below.

$$\text{Setting (\%)} = \frac{I_{\text{limit}} \text{ (A)}}{I_{\text{ref}} \text{ (A)}} \times 100$$

(Example) Setting the current limiting level I_{limit} at 4.2 A for 0.75 kW standard motors

$$\text{Setting (\%)} = \frac{4.2 \text{ (A)}}{5.0 \text{ (A)}} \times 100 = 84$$

The reference current is given in the table for F20 to F22 on page 5-24.

- Note**
- The current limiting feature selected by F43 and F44 are implemented by software, so an operational delay may occur. To avoid the delay, use the current limiter (hardware) simultaneously (H12 = 1).
 - If an overload is applied when the limiting level is set extremely low, the inverter will immediately lower its output frequency. This may cause an overvoltage trip or dangerous turnover of the motor rotation due to undershooting.

WARNING

If the current limiter function has been activated, the inverter may operate at an acceleration/deceleration time or frequency different from the set ones. The machine should be so designed that safety is ensured even in any current limiter operation.

Otherwise an accident could occur.

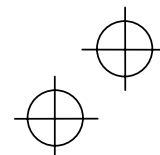
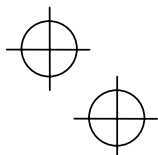

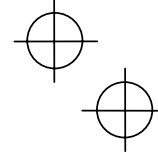
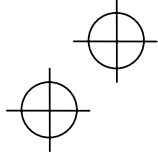

F50, F51 Electronic Thermal (Discharging capability and Allowable average loss)

These function codes configure the electronic thermal overload relay to protect the braking resistor from overheating.

Set the discharging capability and allowable average loss to F50 and F51, respectively. Those values differ depending upon the specifications of the braking resistor. Refer to the tables on the next page.

Note Depending on the discharging capability margin of a braking resistor, the electronic thermal function may operate and issue the overheat alarm "dbH," even if the actual temperature of the resistor is lower than that specified. Check braking resistor performance again and review the data setting of function codes F50 and F51.

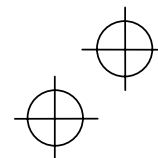
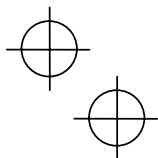

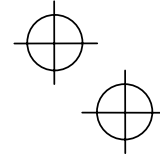
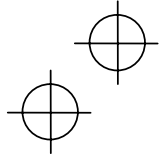

The following tables list the discharging capability and allowable average loss of the Jaguar CUB series inverters. These values are determined by inverter model and specifications of braking resistors.

■ External braking resistor

Power supply voltage	Inverter type	Braking resistor type	Q'ty	Resistance (Ω)	Capacity (W)	Continuous braking (Braking torque: 100%)		Repetitive braking (Period: 100 sec. or less)		
						Discharging capability (kW)	Braking time (s)	Allowable average loss (kW)	Duty cycle (%ED)	
Three-phase 200V	CUB3A-2	See IMO	1	100	200	50	250	0.075	37	
	CUB5A-2						133		20	
	CUB8A-2	See IMO		40	400	55	73	0.110	14	
	CUB11A-2						50		10	
Three-phase 400V	CUB17A-2	See IMO	33	400	140	75	0.185	10		
	CUB1A5-4	See IMO	200	200	50	250	0.075	37		
	CUB2A5-4					133		20		
	CUB3A7-4	See IMO	160	400	55	73	0.110	14		
	CUB5A-4					50		10		
	CUB9A-4	See IMO	130	140	75	0.185	10			
	Single-phase 200V	CUB3A-1	See IMO	1	100	200	50	250	0.075	37
		CUB5A-1						133		20
CUB8A-1		See IMO	40		400	55	73	0.110	14	
CUB11A-1							50		10	

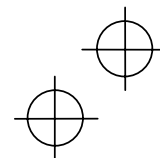
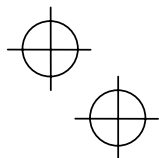

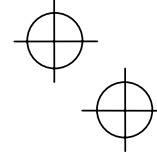
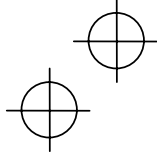

E01 to E03, E98, E99 Terminal Command Assignment to [X1] to [X3], [FWD] and [REV]

E01 to E03, E98 and E99 may assign commands (listed below) to terminals [X1] to [X3], [FWD], and [REV] which are general-purpose programmable input terminals.

These function codes may also switch the logic system between normal and negative to define how the inverter logic interprets either ON or OFF status of each terminal. The default setting is normal logic, that is "Active ON."

To assign negative logic input to any input terminal, set the function code to the value of 1000s shown in () in Section 5.1 " Function Code Tables." To keep explanations as simple as possible, the examples shown below are all written for the normal logic system.

- Select multistep frequency (1 to 7 steps)--(SS1), (SS2), and (SS4)
(Function code data = 0, 1, and 2)

Switching digital input signals (SS1), (SS2), and (SS4) on/off may switch the set frequency to those defined by function codes C05 through C11 (multistep frequencies). With this, the inverter may drive the motor at 8 different preset speeds.

The table below lists the frequencies that can be obtained by the combination of switching (SS1), (SS2), and (SS4). In the "Selected frequency" column, "Other than multistep frequency" represents the set frequencies defined by frequency command 1 (F01), frequency command 2 (C30), or others.

Terminal [X3] (E03)	Terminal [X2] (E02)	Terminal [X1] (E01)	Selected frequency
2 (SS4)	1 (SS2)	0 (SS1)	
OFF	OFF	OFF	Other than multistep frequency
OFF	OFF	ON	C05 (multistep frequency 1)
OFF	ON	OFF	C06 (multistep frequency 2)
OFF	ON	ON	C07 (multistep frequency 3)
ON	OFF	OFF	C08 (multistep frequency 4)
ON	OFF	ON	C09 (multistep frequency 5)
ON	ON	OFF	C10 (multistep frequency 6)
ON	ON	ON	C11 (multistep frequency 7)

- Select acceleration/deceleration (2 steps)--(RT1)
(Function code data = 4)

Digital input signal (RT1) assigned to the specified terminal on/off may switch combinations between acceleration/deceleration time 1 (defined by function codes F07 and F08) and acceleration/deceleration time 2 (defined by E10 and E11).

Turning (RT1) on, for example, enables the inverter to drive the motor using acceleration/deceleration time 2.

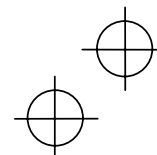
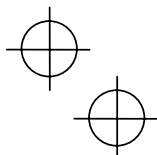

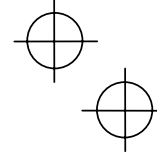
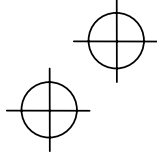

- Select 3-wire operation command--(HLD)
(Function code data = 6)

Digital input signal (HLD) may self-hold the forward (FWD)/reverse (REV) run commands given at the external signal input terminals to enable 3-wire inverter operation.

Shorting the circuit between the (HLD)-assigned terminal and terminal [CM] will self-hold the (FWD) or (REV) command. Opening the circuit will release the hold.

- Coast-to-stop command--(BX)
(Function code data = 7)

Shorting the circuit between the (BX)-assigned terminal and terminal [CM] will immediately stop the inverter output so that the motor will coast to a stop without issuing any alarms.

- Reset alarm--(RST)
(Function code data = 8)

When the protection function has been activated (the inverter is in Alarm mode), shorting the circuit between the (RST)-assigned terminal and terminal [CM] will reset the alarm output on terminals [Y1] and [30A,B,C]. Opening the circuit will release all the alarm indications to restart operation. Allow 10 ms or more for the short-circuit time.

(RST) should be kept off for normal inverter operation.

- Alarm from external equipment--(THR)
(Function code data = 9)

When the motor is running, opening the circuit between the (THR)-assigned terminal and terminal [CM] will immediately stop the inverter output and issue the alarm "OH2." The motor will coast to a stop.

- Ready for jogging--(JOG)
(Function code data = 10)

Turning on the (JOG) command makes the motor ready for jogging. Use this command for fine adjustment to position a workpiece, for example.

When the motor is ready for jogging with (JOG) being on, pressing the  key or turning the (FWD) or (REV) command on will start the motor to jog.



If the  key is released, the motor will decelerate to a stop.

Jogging operation follows the settings of:

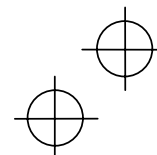
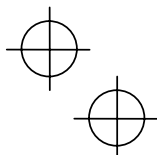

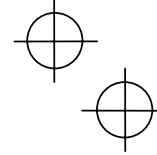
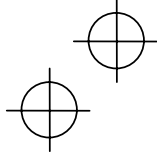
- Jogging frequency set by function code C20
- Acceleration or deceleration time set by function code H54







Simultaneous  +  keying may also make the motor ready for jogging depending upon whether keypad operation or terminal command operation is selected and whether the (JOG) command is on or off, as listed below.

When operated from keypad (F02 = 0, 2, or 3)

If (JOG) is:	 +  keys	The motor becomes ready for:
ON	Disabled.	Jogging
OFF	Toggles between normal and jogging.	Normal running
		Jogging

When terminal command operation is selected (F02 = 1), simultaneous  +  keying is disabled.

- Select frequency command 2 or 1--(Hz2/Hz1)
(Function code data = 11)

Turning the digital input signal (Hz2/Hz1) on/off may switch the frequency command means between frequency command 1 (defined by function code F01) and frequency command 2 (defined by function code C30).

Turning the (Hz2/Hz1) command on allows the frequency command 2 to be selected.

- Enable editing of function code data from the keypad--(WE-KP)
(Function code data = 19)

Turning off the (WE-KP) command prohibits changing of function code data from the keypad.

Only when the (WE-KP) command is on, you may access function code data from the keypad according to the setting of function code F00 as listed below.

If (WE-KP) is set to:	F00	Function
ON	0	Permit editing of function code data
	1	Inhibit editing of function code data except F00
OFF	Disabled	Inhibit editing of function code data

If the (WE-KP) command is not assigned to any terminal, the inverter will interpret (WE-KP) as being always on.

- Disable PID control--(Hz/PID)
(Function code data = 20)

Turning the (Hz/PID) command on/off enables or disables the PID control.

If the PID control is disabled with the (Hz/PID) being off, the inverter runs the motor with the frequency manually set by any of multistep, keypad, or analogue input.

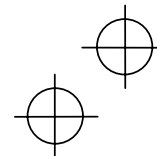
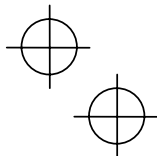

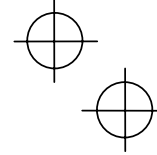
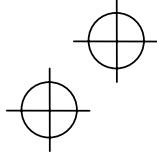

■ Switch Normal/Inverse operation--(IVS)
(Function code data = 21)

Turning the (IVS) command on/off switches the output frequency control between normal (proportional to the set frequency components) and inverse operation for the PID process or manually set frequencies. To select the inverse operation, turn the (IVS) command on.

When the PID control is enabled, turning the (IVS) command on inverts the PID process control selected by function code J01. For example, if the PID process control is normal, turning it on switches it to inverse, or vice versa.

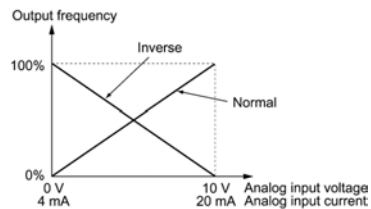

■ Select link operation--(LE)
(Function code data = 24)

Turning on the (LE) command selects link operation. The inverter will run the motor with the frequency command or drive command given via the RS485 communications facility defined by function code H30.

If the (LE) command is not assigned to any terminal, the inverter will interpret (LE) as being always on.

■ Reset PID integral and differential components--(PID-RST)
(Function code data = 33)

Turning on the (PID-RST) command resets the PID integral and differential components.

■ Hold PID integral component--(PID-HLD)
(Function code data = 34)

Turning on the (PID-HLD) command holds the current inverter output voltage constant by suppressing an increase of PID integral component.

■ Run forward--(FWD)
(Function code E98/E99 data = 98)

If the (FWD) command is turned on, the inverter runs the motor forward; if off, it decelerates the motor to a stop.

■ Run reverse--(REV)
(Function code E98/E99 data = 99)

If the (REV) is turned on, the inverter runs the motor in reverse; if off, it decelerates the motor to a stop.

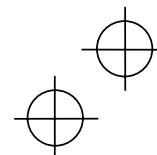
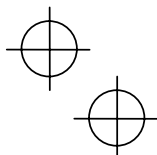

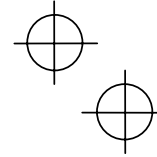
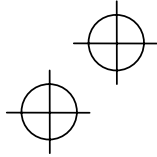

E20, E27 Status Signal Assignment to [Y1], [30A], [30B] and [30C]

E20 and E27 may assign output signals to terminals [Y1] (transistor switch) and [30A], [30B] and [30C] (mechanical relay contacts) which are general-purpose programmable output terminals.

These function codes may also switch the logic system between normal and negative to define how the inverter logic interprets either ON or OFF status of each terminal.

Terminals [30A], [30B], and [30C] are mechanical relay contacts. In the normal logic, if an alarm occurs, the relay will be ordinarily excited so that [30A] and [30C] will be short-circuited, signaling an occurrence of the error to external equipment. On the other hand, in the negative logic, the relay will cut off the excitation current to open [30A] and [30C]. This may be useful for the implementation of fail-safe power systems.

Note When negative logic is active, the inverter switches all output signals to the active side (for example, the alarm side). To avoid system malfunctions caused by this, interlock the signals to keep them on using an external power source.

Since terminals [30A/B/C] are mechanical relay contacts, they cannot withstand frequent on/off operations. If frequent signal outputs are expected e.g., assigning any current limiter signal and activating the current limiter actively, then use [Y1]. For rare signal outputs, e.g., for inverter protection purpose, use [30A/B/C].

The service life of a mechanical relay contact is 200,000 on/off operations at one-second intervals.

To keep explanations as simple as possible, the examples shown below are all written for the normal logic system.

- Inverter running (Speed > 0)--(RUN)
(Function code data = 0)

This output signal is used to tell the external equipment that the inverter is running at a speed higher than 0. It switches on when the inverter output frequency exceeds the starting frequency of the motor. It switches off when it is less than the starting frequency or the inverter is DC-braking the motor.

- Frequency equivalence--(FAR)
(Function code data = 1)

This signal is turned on when the difference between the output and set frequencies comes into the allowable error zone (prefixed to 2.5 Hz).

- Frequency detection--(FDT)
(Function code data = 2)

This signal is turned on when the output frequency of the inverter comes into the frequency detection level specified by function code E31. It is turned off when the output frequency drops lower than the detection level for 1 Hz (hysteresis band of the frequency comparator: prefixed at 1 Hz).

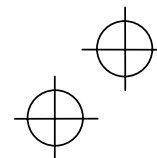
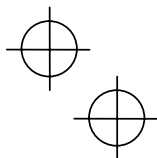

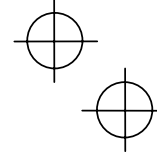
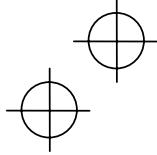

■ Undervoltage detection--(LU)
(Function code data = 3)

This signal is turned on when the DC link circuit voltage of the inverter drops below the specified level or when the motor stops due to activation of the undervoltage protection feature (undervoltage trip). It is turned off if the DC link circuit voltage exceeds the specified level.

■ Torque limiting (Current limiting)--(IOL)
(Function code data = 5)

This signal is turned on when the inverter is limiting the motor drive current by activating the current limiter of either software (F43: Operation condition, F44: Limiting level) or hardware (H12 = 1: Active). The minimum ON-duration is 100 ms.

■ Auto-restart after recovery of power--(IPF)
(Function code data = 6)

This signal is turned on during the period from when the inverter detects the undervoltage of the DC link circuit and stops the output (if auto-restart after recovery of power is selected (F14 = 4 or 5)) until auto-restarting (the output frequency has recovered up to the set frequency). At that moment of auto-restarting, this signal is turned off.

■ Motor overload early warning--(OL)
(Function code data = 7)

This signal is used to issue a motor overload early warning for enabling you to take corrective action before the inverter detects a motor overload (OL1 alarm) and stops its output.

The motor temperature characteristics are specified by function codes F10 (Electronic thermal selection) and F12 (Thermal time constant). If a value calculated from the settings of F10 and F12 exceeds the detection level of the early warning set by function code E34, then this signal is turned on. Normally, the recommended set current level for E34 is 80 to 90% of the allowable continuous load current set by function code F11.

Note Function code E34 is effective for not only the motor overload early warning (OL), but also for the operation level of the current detection (ID) and low level current detection (IDL).

■ Retry in operation--(TRY)
(Function code data = 26)

This signal is turned on when the retry function specified by function codes H04 (Number of retries) and H05 (Latency time) is activated. Refer to function codes H04 and H05 for details of the output timing and number of retries.

■ Service life alarm--(LIFE)
(Function code data = 30)

This signal is turned on when it is judged that the service life of any of capacitors (DC bus capacitor and electrolytic capacitor on the printed circuit board) and cooling fan has expired.

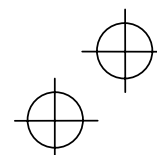
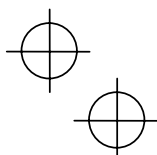

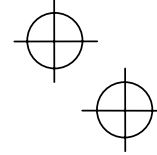
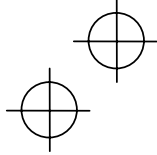

This function provides an calculated information for service life of the parts. If this signal is issued, check the service life of these parts in your system according to the maintenance procedure to determine whether the parts should be replaced or not. To maintain stable and reliable operation and avoid unexpected failures, daily and periodic maintenance must be performed.

 For details, refer to Chapter 7, Section 7.2, Table 7.2 " Replacement Parts Judgement with Menu #5 "Maintenance Information" as a Guide."

- Inverter running--(RUN2)
(Function code data = 35)

This signal is turned on when the motor is driven by the frequency higher than the starting frequency or the DC braking is activated.

- Overload prevention control--(OLP)
(Function code data = 36)

This signal is turned on when the overload prevention function is activated if the frequency drop rate comes to be the setting specified by function code H70. The minimum ON-duration is 100 ms.

 For details of the overload prevention control, refer to the descriptions of function code H70.

- Current detection--(ID)
(Function code data = 37)

This signal is turned on when the output current exceeds the operation level specified by function code E34 and stays in this status for the duration specified by function code E35 (on delay timer). The minimum ON-duration is 100 ms.

 **Note** Function codes E34 and E35 are effective not only for the current detection (ID), but also for the operation level of the overload early warning (OL) and low-level current detection (IDL), and the setting of the timer count.

- Low level current detection--(IDL)
(Function code data = 41)

This signal is turned on when the output current drops below the operation level specified by function code E34 and stays in this status for the duration specified by function code E35 (on delay timer). The minimum turning-ON time is 100 ms.

 **Note** Function codes E34 and E35 are effective not only for the low-level current detection (IDL), but also for the operation level of the overload early warning (OL) and current detection (ID), and the setting of the timer count.

- Alarm relay contact output (for any fault)--(ALM)
(Function code data = 99)

This signal is turned on if the protection function is activated so that the inverter enters Alarm mode.

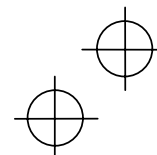
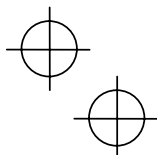

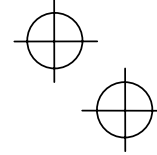
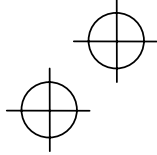

E50	Coefficient for Speed Indication
------------	---

This function code sets a coefficient to be used for setting the constant rate of feeding time, load shaft speed or line speed and for displaying its output status.

$$\text{Const. Rate of Feeding Time (min)} = \frac{\text{Coeff. of Speed Indication (E50)}}{\text{Freq.} \times \text{Coeff. for Const. Rate of Feeding Time (E39)}}$$
$$\text{Load Shaft Speed (rpm)} = (\text{E50: Coeff. for Speed Indication}) \times \text{Frequency (Hz)}$$
$$\text{Line Speed (m/min)} = (\text{E50: Coeff. for Speed Indication}) \times \text{Frequency (Hz)}$$

Where, Freq. is the set frequency if each expression is for one of the set data for the constant rate of feeding time, load shaft speed, or line speed; it is the output frequency if each expression is for the output status monitor.

Note PID display coefficients A and B (E40 and E41) are the exclusive conversion factors to equate an indicated value with the process command and feedback amount in PID control.

C21	Timer Operation
------------	------------------------

Enables or disables timer operation. If it is enabled, entering a run command will run the inverter to drive the motor for the period preset to the timer.

An example of timer operation

Setting up the timer conditions beforehand

- Set C21 to 1 to enable timer operation.
- To display the timer count on the LED monitor, set function code E43 (LED monitor) to 13 (Timer count).
- Set up the frequency for the timer operation using the built-in potentiometer or the and keys. If the LED displays the timer count, press the key to switch it to the speed monitor and then set the frequency for the timer operation.

Timer operation (by giving a run command with the key)

- 1) Use the or key to set the timer count (in seconds) while monitoring the current count displayed on the LED monitor. Note that the timer count is expressed as integers.
- 2) Press the key to run the motor, and the timer will start the countdown. The moment the timer finishes the countdown, the inverter stops running the motor even if the key is not pressed. (Timer operation is possible even when the timer count is not displayed on the LED monitor.)
- 3) After the inverter decelerates the motor to a stop, the timer count on the LED monitor will flash.

Note If timer operation started by the terminal command (FWD) is finished and the inverter decelerates the motor to a stop, then the LED monitor displays "End " and the monitor indication ("O" if the timer count is selected) alternately. Turning (FWD) off will switch the LED back to the monitor indication.

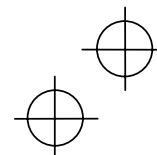
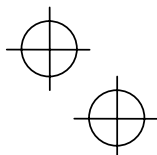

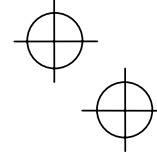
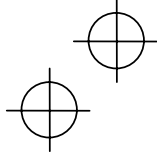

P02, P03 Motor Parameters (Rated capacity and Rated current)

Sets the nominal rated capacity that is denoted on the rating nameplate of the motor.

Note For the CUB9A-4□, CUB17A-2□, the default setting for P02 is 3.7.

P09 Motor Parameter (Slip compensation gain)

Sets the gain to compensate for the motor slip frequency. It is based on the typical slip of every inverter model as 100%. It sets the compensation gain watching the motor speed.

Typical rated slip frequencies for 100%

Rated capacity (kW/HP)	Standard motors (Hz)	Typical motors rated in HP (Hz)	Conventional motors (Hz)	Other motors (Hz)
0.06/0.1	1.77	2.50	1.77	1.77
0.1/0.12	1.77	2.50	1.77	1.77
0.2/0.25	2.33	2.50	2.33	2.33
0.4/0.5	2.40	2.50	2.40	2.40
0.75/1	2.33	2.50	2.33	2.33
1.5/2	2.00	2.50	2.00	2.00
2.2/3	1.80	1.17	1.80	1.80
3.7/5	1.93	1.50	1.93	1.93

The above values apply to both the 200 V and 400 V series of inverters.

Note For this function which is related with the motor characteristics, the voltage at the base frequency (F05) and motor parameters (P codes) should be also set consistently.

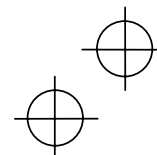
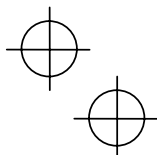

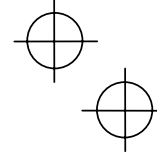
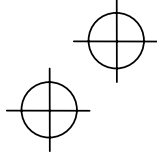

P99 Motor Selection

To use automatic control features (e.g., the auto torque boost/auto energy saving and slip compensation) or overload protection for the motor (electronic thermal), the inverter invokes the parameters and characteristics of the motor. To match the driving characteristics between the inverter and motor, set the motor characteristics with this function code and set H03 to "2" to initialize the motor parameter. This action automatically updates the data of function codes P03, P09 and the constants used inside the inverter.

Motors	P99 =
Standard motors	0
Typical motors rated in HP	1
Conventional motors	3
Other motors	4

- Note**
- For other motors (P99 = 4), the parameters for a standard motor may be applicable.
 - The inverter also supports motors rated by HP (horse power: typical in the North America area, P99 = 1).

H03 Data Initialization

Initializes the current function code settings to the factory defaults or initializes the motor constants (parameters).

To change the H03 data, it is necessary to press the and keys or the and keys simultaneously.

If H03 is set to:	Function
0	Disable initialization (Settings made by the user manually will be retained.)
1	Initialize all function code data to the factory defaults
2	Initialize the P03 data (Rated current of the motor) and internally used constants to the motor constants determined by P02 data (Motor capacity) and P99 (Motor characteristics), as listed on the next page. Initialize P09 data (Slip compensation gain) to 0.0.

- To initialize the motor constants, set the related function codes as follows.
 - 1) P02 Motor Parameters: Set the rated capacity of the motor to be used in kW.
(Rated capacity)
 - 2) P99 Motor Selection: Select the characteristics of the motor. (Refer to the descriptions given for P99.)
 - 3) H03 Data Initialization: Initialize the motor constants. (H03=2)
 - 4) P03 Motor Parameters: Set the rated current printed on the nameplate if the set data differs from the rated current.
(Rated current):
- After completion of the initialization, the H03 data returns to 0 (default setting).
- If any value out of the general motor capacity is set to P02, the capacity will be internally converted to the applicable motor rating (see the table on the next page).

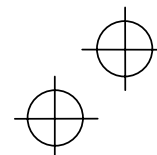
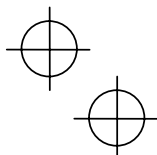

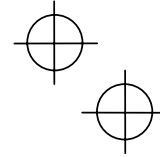
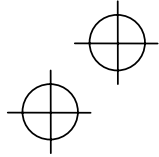

■ If P99 (Motor characteristics) is set to 0 (Standard motors), 3 (Conventional motors), or 4 (Other motors):

Power supply voltage	Setting range (kW) Function code P02	Applicable motor rating (kW)	Rated current (A)		
			If P99 (Motor selection) is set to:		
			0	3	4
Three-phase 200V Single-phase 200V	0.01 to 0.06	0.06	0.44	0.44	0.44
	0.07 to 0.10	0.1	0.68	0.68	0.68
	0.11 to 0.20	0.2	1.30	1.30	1.30
	0.21 to 0.40	0.4	2.30	2.30	2.30
	0.41 to 0.75	0.75	3.60	3.60	3.60
	0.76 to 1.50	1.5	6.10	6.10	6.10
	1.51 to 2.20	2.2	9.20	9.20	9.20
	2.21 to 3.70	3.7	15.00	15.00	15.00
	3.71 to 5.50	5.5	22.00	22.00	22.00
	5.51 to 10.00	7.5	29.00	29.00	29.00
Three-phase 400V	0.01 to 0.06	0.06	0.22	0.22	0.22
	0.07 to 0.10	0.1	0.34	0.34	0.34
	0.11 to 0.20	0.2	0.65	0.65	0.65
	0.21 to 0.40	0.4	1.15	1.15	1.15
	0.41 to 0.75	0.75	1.80	1.80	1.80
	0.76 to 1.50	1.5	3.05	3.05	3.05
	1.51 to 2.20	2.2	4.60	4.60	4.60
	2.21 to 3.70	3.7	7.50	7.50	7.50
	3.71 to 5.50	5.5	11.00	11.00	11.00
	5.51 to 10.00	7.5	14.50	14.50	14.50

NOTE: The above values in the "Rated current" column are applicable to four-pole standard motors rated for 200 V and 400 V at 50 Hz. If you use non-standard motors, change the P02 data to the rated current printed on the motor's nameplate.

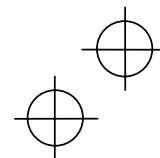
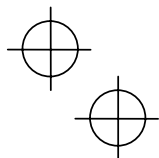

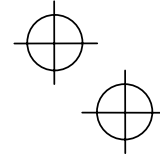
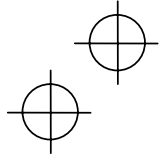

■ If P99 (Motor characteristics) is set to 1 (HP motors):

Power supply voltage	Setting range (HP)	Applicable motor rating (HP)	Rated current (A)
	Function code P02		If P99(Motor selection) is set to:
Three-phase 200V Single-phase 200V	0.01 to 0.10	0.1	0.44
	0.11 to 0.12	0.12	0.68
	0.13 to 0.25	0.25	1.40
	0.26 to 0.50	0.5	2.00
	0.51 to 1.00	1	3.00
	1.01 to 2.00	2	5.80
	2.01 to 3.00	3	7.90
	3.01 to 5.00	5	12.60
	5.01 to 7.50	7.5	18.60
	7.51 to 10.00	10	25.30
Three-phase 400V	0.01 to 0.10	0.1	0.22
	0.11 to 0.12	0.12	0.34
	0.13 to 0.25	0.25	0.70
	0.26 to 0.50	0.5	1.00
	0.51 to 1.00	1	1.50
	1.01 to 2.00	2	2.90
	2.01 to 3.00	3	4.00
	3.01 to 5.00	5	6.30
	5.01 to 7.50	7.5	9.30
	7.51 to 10.00	10	12.70

NOTE: The above values in the "Rated current" column are exclusively applicable to a four-pole standard motors rated for 200 V and 400 V at 60 Hz. If you use non-standard or other manufacturer's motors, change the P02 data to the rated current printed on the motor's nameplate.

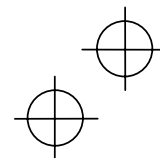
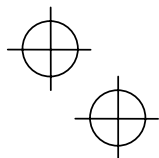

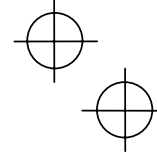
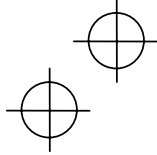

H04, H05 Retry (No. of retries, Waiting time)

To automatically exit from the alarm status and restart the inverter, use the retry functions. The inverter automatically exits from Alarm mode and restarts without issuing a block alarm even if it has entered the forced Alarm mode. If the inverter has entered Alarm mode many times in excess of the number of times specified by function code H04, it issues a block alarm and does not exit Alarm mode for restarting.

Listed below are the recoverable alarm statuses of the inverter.

Alarm status	LED monitor display	Alarm status	LED monitor display
Instantaneous over-current protection	OC1, OC2 or OC3	Braking resistor over-heated	dbH
Overvoltage protection	OU1, OU2 or OU3	Motor overloaded	OL1
Heat sink overheated	OH1	Inverter overloaded	OLU
Motor overheated	OH4		

■ No. of retry times (H04)

Set the number of retry times for automatic exit from Alarm mode. If the inverter has entered Alarm mode during the retry times specified, the inverter issues a block alarm and will not exit from Alarm mode for restarting.

WARNING

If the retry function has been activated, the inverter will automatically restart when the power is recovered, according to some tripping causes. Design the machine so that human body and peripheral equipment safety is ensured even after automatic re-starting.

Otherwise an accident could occur.

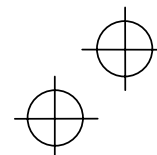
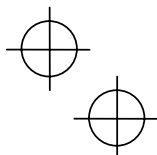

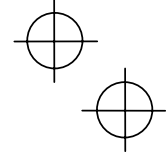
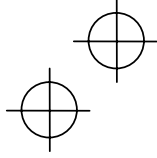

■ Retry waiting time (H05)

Sets the waiting time for automatic exit from Alarm mode. Refer to the timing scheme diagram below.

Operation timing chart

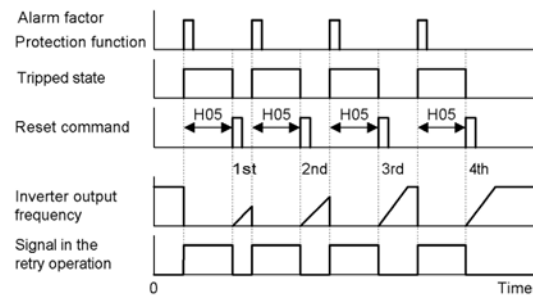

H07 Gradual Acceleration/Deceleration

Specifies the acceleration and deceleration patterns (output frequency patterns).

Linear acceleration/deceleration

The inverter runs the motor with the constant acceleration and deceleration.

S-curved acceleration/deceleration

To reduce the impact on the inverter-driven motor during acceleration/deceleration, the inverter gradually accelerates/decelerates the motor in both the acceleration/deceleration zones.

Curvilinear acceleration/deceleration

The inverter drives the motor to output maximum performance with a constant loading rate as follows:

- In the zone under the base frequency, linear acceleration/deceleration of constant torque output for the motor
- In the zone above the base frequency, speed two times the base frequency and acceleration/deceleration half of the base frequency

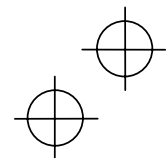
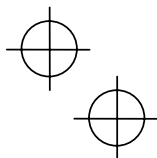

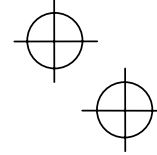
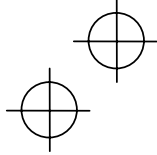

H12 Instantaneous Overcurrent Limiting

Selects whether the inverter will perform current limiting processing or cause an overcurrent trip if the output current exceeds the instantaneous overcurrent limit level.

If the instantaneous overcurrent limiting is enabled, the inverter will immediately turn off its output gates to suppress the increase of current and control the output frequency.

If current limiting processing makes the motor decrease its torque temporarily so as to cause any problem, then disable overcurrent limiting to cause an overcurrent trip and apply brake to the motor.

Note The same functions to limit the output current are implemented by software as function codes F43 and F44. Generally, software features have an operation delay, so enable function code H12 as well.

Depending upon the load, acceleration in an extremely short period may activate the current limiter to suppress the increase of the inverter output frequency, causing the system oscillate (hunting) or making the inverter enter the *OU* alarm mode and trip. When setting the acceleration time, therefore, you need to take into account the load condition and moment of inertia.

H69 Regenerative Energy Suppressing

The moment a regenerative energy exceeding the braking capacity of inverter is returned during deceleration, the inverter will stop its output and enter overvoltage Alarm mode. If regenerative energy suppressing control is enabled, the inverter lengthens the deceleration time to 3 times the preset time and decreases the deceleration torque to 1/3 when the DC link voltage exceeds the preset voltage suppressing level. In this way, the inverter makes the motor reduce the regenerative energy tentatively.

Note This control is used to suppress the torque generated by the motor in deceleration. Conversely, when the load on the motor results in a braking effect, the control does not have any effect, so do not use it in this case.

Disable this control when the inverter features a braking resistor. If it is enabled, the braking resistor and regenerative energy suppressing control may conflict with each other, which may change the deceleration time unexpectedly.

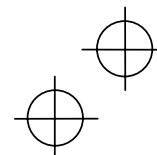
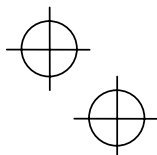

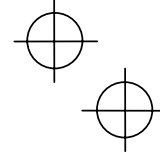
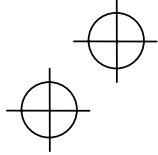

H70 Overload Prevention Control

Enables or disables the overload suppressing control. If enabled, this function code is used to set the deceleration (Hz/s).

Before the inverter enters Alarm mode due to the heat sink overheat or overload (alarm code: *OH1* or *OLU*), this control decreases the output frequency of the inverter to suppress the trip.

Apply this control to equipment (such as pumps) whose drive frequency drops in line with any decrease in load. If you want to proceed to drive such kind of equipment even the inverter slows down the output frequency, enable this control.

Note Do not use this control to equipment whose load does not slow if the inverter output frequency drops, as it will have no effect.

If the following functions to limit the output current are enabled (F43 ≠ 0 and H12 = 1), this control does not work.

H96 Priority on STOP Key/Start Check

The inverter can be operated using a functional combination of "Priority on STOP Key" and "Start Check."

■ STOP key priority

Pressing the  key on the keypad forces the inverter to decelerate and stop the motor even if the inverter is running by any run commands given via the terminals or communications (link operation). After the motor stops, the inverter issues alarm "Er6."

■ Start check function

The inverter prohibits any run commands to be executed and displays "Er6" on the LED of keypad when:

- The power is first applied.
- The  key is pressed or the (RST) signal is turned on to cancel the alarm.
- Link command (LE) has switched inverter operations.

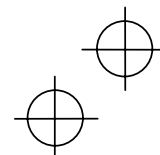
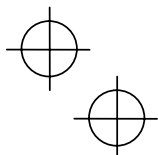

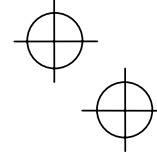
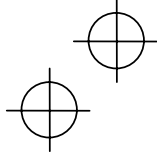

H98 Protection/Maintenance (Selection)

Specifies a combination between automatic lowering of carrier frequency, output phase loss protection, input phase loss protection.

Automatic lowering of carrier frequency

Select this feature to protect the system from any failure which could result from the inverter tripping due to the heat sink overheating (*OH1*) or overload (*OLU*), abnormally high ambient temperature or a cooling mechanism failure. This feature lowers the output frequency before the inverter enters Alarm mode. However, the level of motor noise may increase.

Input phase loss protection (*L 1n*)

If a phase loss is detected in the three-phase input power source, the inverter will enter Alarm mode and issue an alarm (*L 1n*). This prevents the inverter from undergoing heavy stress that may be caused by input phase loss or interphase voltage unbalance exceeding 6%.

Note If connected load is light or a DC reactor is connected to the inverter, this function will not detect input phase loss if any.

For inverters with single-phase input, this protection does not take effect. Do not enable it. When you single-phase an inverter designed for a three-phase input for the testing purposes, you may disable this protection only if you can reduce its load.

Output phase loss protection (*OPL*)

The inverter will enter the alarm mode activated by the output phase loss protection, and issue the alarm *OPL* if it detects an output phase loss while it is running.

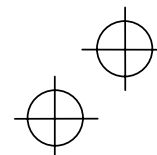
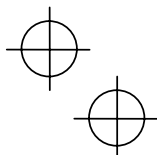

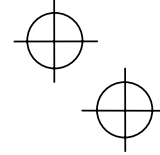
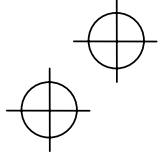

TROUBLESHOOTING

6.1 Before Proceeding with Troubleshooting

WARNING

If any of the protective functions have been activated, first remove the cause. Then, after checking that the all run commands are set to off, reset the alarm. Note that if the alarm is reset while any run commands are set to on, the inverter may supply the power to the motor which may cause the motor to rotate.

Injury may occur.

- Even though the inverter has interrupted power to the motor, if the voltage is applied to the main circuit power input terminals L1/R, L2/S and L3/T (L1/L and L2/N for single-phase voltage input), voltage may be output to inverter output terminals U, V, and W.
- Some electric charge may remain in the DC bus capacitor even after the power is turned off. Therefore, it may take some time until the DC link circuit voltage reaches a safe level. Before touching the circuit, wait for at least five minutes after the power has been turned off and check that the DC voltage between main circuit terminals P (+) and N (-) is less than +25 VDC using a multimeter.

Electric shock may occur.

Follow the procedure below to solve problems.

- (1) First, check that the inverter is correctly wired, referring to Chapter 2, Section 2.3.5 "Wiring for Main Circuit Terminals and Grounding Terminals."
- (2) Check whether an alarm code is displayed on the LED monitor.

If no alarm code appears on the LED monitor

- Motor is running abnormally → Go to Section 6.2.1.
- Problems with inverter settings → Go to Section 6.2.2.

If an alarm code appears on the LED monitor → Go to Section 6.3.

If any problems persist after the above recovery procedure, contact the Company where you purchased the inverter or contact IMO.

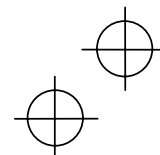
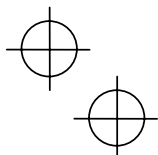

■ Quick reference table of alarm codes

Alarm code	Name	Refer to	Alarm code	Name	Refer to
<i>OC1</i>	Overcurrent protection	p.6-9	<i>OH4</i>	PTC thermistor for motor protection	p.6-13
<i>OC2</i>			<i>dbH</i>	Overheat protection for braking resistor	p.6-14
<i>OC3</i>			<i>OL1</i>	Electronic thermal overload relay	p.6-14
<i>OU1</i>	Overvoltage protection	p.6-10	<i>OLU</i>	Overload protection	p.6-15
<i>OU2</i>			<i>Er1</i>	Memory error	p.6-15
<i>OU3</i>			<i>Er2</i>	Remote keypad communications error	p.6-16
<i>LU</i>	Undervoltage protection	p.6-10	<i>Er3</i>	CPU error	p.6-16
<i>L in</i>	Input phase loss protection	p.6-11	<i>Er6</i>	Operation protection	p.6-17
<i>OPL</i>	Output phase loss protection	p.6-12	<i>Er8</i>	RS485 communications error	p.6-17
<i>OH1</i>	Overheat protection for heat sink	p.6-12	<i>ErF</i>	Data save error during undervoltage	p.6-18
<i>OH2</i>	External alarm input	p.6-13			

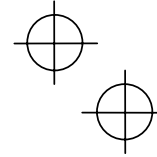
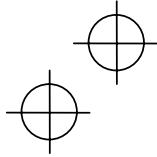

6.2 If no alarm code appears on the LED monitor

6.2.1 Motor is running abnormally

[1] The motor does not rotate.

Possible Causes	What to Check and Suggested Measures
(1) No power supplied to the inverter.	Check the input voltage, output voltage and interphase voltage unbalance. → Turn on a moulded case circuit breaker, an earth leakage circuit breaker (with the exception of those exclusively designed for protection from ground faults) or a magnetic contactor. → Check for voltage drop, phase loss, poor connections, or poor contacts, and fix them if necessary.
(2) No forward/reverse operation command was inputted, or both the commands were inputted simultaneously (external signal operation).	Check the input status of the forward/reverse command with Menu #4 "I/O checking" using the keypad. → Input a run command. → Set either the forward or reverse operation command to off if both commands are being inputted. → Correct the assignment of commands (FWD) and (REV) to function codes E98 and E99. → Connect the external circuit wires to control circuit terminals [FWD] and [REV] correctly.
(3) No indication of rotation direction (keypad operation).	Check the input status of the forward/reverse rotation direction command with Menu #4 "I/O checking" using the keypad. → Input the rotation direction (F02=0), or select the keypad operation with which the rotation direction is fixed (F02=2 or 3).
(4) The inverter could not accept any run commands from the keypad since it was not in Running mode.	Check which operation mode the inverter is in, using the keypad. → Shift the operation mode to Running mode.
(5) A run command with higher priority than the one attempted was active, and the run command was stopped.	While referring to the block diagram of the drive command generator, check the higher priority run command with Menu #2 "Data checking" and Menu #4 "I/O checking" using the keypad. → Correct any incorrect function code data settings (e.g., cancel the higher priority run command).
(6) The set frequency was set to the same or lower than the value of the starting or stop frequency.	Check that a frequency command has been entered, with Menu #4 "I/O checking" using the keypad. → Set the value of the set frequency to the same or higher than that of the starting or stop frequency (F23 or F25). → Reconsider the starting and stop frequencies (F23 and F25), and if necessary, change them to lower values. → Inspect the frequency command devices, signal converters, switches or relay contacts. Replace any ones that are faulty. → Connect the external circuit wires correctly to terminals [13], [12], [11] and [C1].

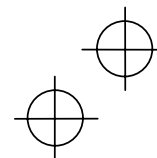
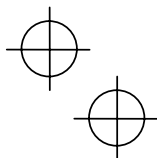

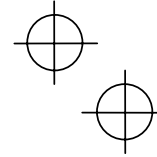
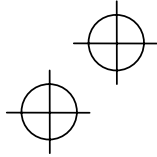

Possible Causes	What to Check and Suggested Measures
(7) A frequency command with higher priority than the one attempted was active.	Check the higher priority run command with Menu #2 "Data checking" and Menu #4 "I/O checking" using the keypad, referring to the block diagram of the drive command generator. → Correct any incorrect function code data settings (e.g. cancel the higher priority run command).
(8) The upper and lower frequencies for the frequency limiters were set incorrectly.	Check the data of function codes F15 and F16. → Change the upper and lower frequencies (F15 and F16) to the correct ones.
(9) The coast-to-stop command was effective.	Check the data of function codes E01, E02, E03, E98 and E99 with Menu #2 "Data checking" and the input signal status with Menu #4 "I/O checking" using the keypad. → Release the coast-to-stop command setting.
(10) Broken wire, incorrect connection or poor contact with the motor.	Check if the output current and connection are correct. → Repair the wires to the motor, or replace them.
(11) Overload	Check that the output current is not too large. → Reduce the load (e.g., operate the mechanical brake correctly).
(12) Torque generated by the motor was insufficient.	Check that the motor starts running if the value of torque boost (F09) is increased. → Increase the value of torque boost (F09) and try to run the motor.
	Check the data of function codes F04, F05, H50, and H51. → Change the V/f pattern to match the motor's characteristics.

[2] The motor rotates, but the speed does not increase.

Possible Causes	What to Check and Suggested Measures
(1) The maximum frequency was set to too low a value.	Check the data of function code F03. → Correct the data of the maximum frequency (F03).
(2) The peak frequency of the frequency limiter was set to too low a value.	Check the data of function code F15. → Correct the data of the peak frequency of the frequency limiter (F15).
(3) The set frequency was set to too low a value.	Check the signals for the set frequency from the control circuit terminals with Menu #4 "I/O checking" using the keypad. → Increase the set frequency. → If an external potentiometer for frequency command, signal converter, switches, or relay contacts are malfunctioning, replace them. → Connect the external circuit wires to terminals [13], [12], [11], and [C1] correctly.

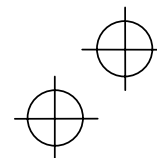
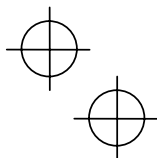

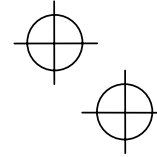
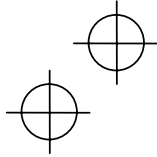

Possible Causes	What to Check and Suggested Measures
(4) A frequency command with higher priority than the one attempted (e.g., multistep frequency, communications or jogging operation, etc.) was active and the set frequency was set to too low a value.	Check the higher priority run command with Menu #2 "Data checking" and Menu #4 "I/O checking" using the keypad, referring to the block diagram of the drive command generator. → Correct any incorrect function code data settings (e.g. cancel the higher priority run command, etc.).
(5) The acceleration/ deceleration time was too long.	Check the data of function codes F07, F08, E10, E11 and H54. → Change the acceleration/deceleration time to match the load.
(6) Overload	Measure the output current. → Reduce the load (e.g., operate the mechanical brake correctly).
(7) The current limiting operation did not increase the output frequency.	Check whether current limiting is active or not with Menu #3 "Drive monitoring" and check the current limiting level (F44) using the keypad. → Change the level of the current limiting (F44) to an appropriate value. Decrease the value of torque boost (F09), then turn the power off and back on again and check if the speed increases. → Adjust the value of the torque boost (F09). Check the data of function codes F04, F05, H50, and H51 to ensure that the V/f pattern is right. → Match the V/f pattern values with the motor ratings.
(8) Bias and gain set incorrectly.	Check the data of function codes F18, C50, C32, C34, C37 and C39. → Change the bias and gain to correct values.

[3] The motor runs in the opposite direction to the command.

Possible Causes	What to Check and Suggested Measures
(1) Wiring has been connected to the motor incorrectly	Check the wiring to the motor. → Connect terminals U, V, and W of the inverter to the respective U, V, and W terminals of the motor.
(2) Incorrect connection and settings for run commands and rotation direction command (FWD) and (REV)	Check the data of function codes E98 and E99 and the connection to terminals [FWD] and [REV]. → Correct the data of the function codes and the connection.
(3) The setting for the rotation direction via keypad operation is incorrect.	Check the data of function code F02. → Change the data of function code F02 to 2 (forward rotation) or 3 (reverse rotation).

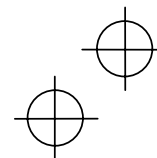
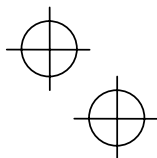

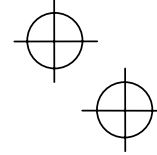
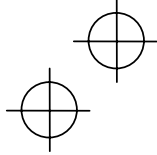

[4] If the speed variation and current vibration (such as hunting) occur at the regular speed

Possible Causes	What to Check and Suggested Measures
(1) The frequency command fluctuated.	Check the signals for the frequency command with Menu #4 "I/O checking" using the keypad. → Increase the filter constants (C33 and C38) for the frequency command.
(2) The external frequency command device was used.	Check that there is no noise in the control signal wires from external sources. → Isolate the control signal wires from the main circuit wires as far as possible. → Use shielded or twisted wires for the control signal.
(3) The slip compensation gain was too large.	Check that the motor vibration is absorbed if the slip compensation (P09) is cancelled. → Correct or cancel the slip compensation (P09) data.
(4) The vibration system having low stiffness in a load caused hunting or the current is irregular due to special motor constants.	Cancel the automatic control system (automatic torque boost, slip compensation, energy saving operation, overload prevention control, current limiting) and check that the motor vibration is suppressed (F37, P09, H70, and F43). → Cancel the functions causing the vibration. → Readjust the data of the oscillation suppression gain (H80) currently set. Check that the motor vibration is suppressed if you decrease the carrier frequency (F26) or set the sound tune to level 0 (F27=0). → Decrease the carrier frequency (F26) or set the sound tune level 0 (F27=0).

[5] If grating sound can be heard

Possible Causes	What to Check and Suggested Measures
(1) The carrier frequency was set too low.	Check the data of function codes F26 and F27. → Increase the carrier frequency (F26). → Select the optimal value to the selection function (F27).

[6] The motor does not accelerate and decelerate at the set time.

Possible Causes	What to Check and Suggested Measures
(1) The inverter ran the motor by S-curve or curvilinear pattern.	Check the data of function code H07. → Select the linear pattern.
(2) The current limiting prevented the output frequency from increasing.	Check that current limiting is enabled with Menu #3 "Drive monitoring" and check the current limiting level (F44) using the keypad. → Change the current limiting level (F44) to a correct value. → Increase the acceleration and deceleration time (F07, F08, E10, and E11).

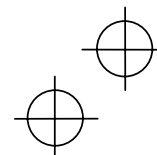
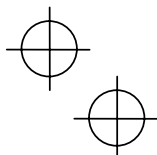

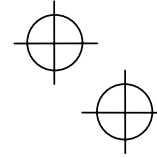
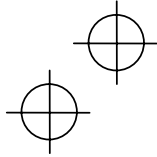

Possible Causes	What to Check and Suggested Measures
(3) The automatic deceleration was active.	Check the data of function code H69. → Consider the use of a braking resistor. → Increase the deceleration time (F08 and E11).
(4) Overload	Measure the output current. → Reduce the load.
(5) Torque generated by the motor was insufficient.	Check that the motor starts running if the value of the torque boost (F09) is increased. → Increase the value of the torque boost (F09).
(6) An external frequency command device is being used.	Check that there is no noise in the external signal wires. → Isolate the control signal wires from the main circuit wires as far as possible. → Use shielded wire or twisted wire for the control signal wires.

[7] Even if the power recovers after an instantaneous power failure, the motor does not restart.

Possible Causes	What to Check and Suggested Measures
(1) The setting of function code F14 did not make the motor restart even if the power recovered after an instantaneous power failure.	Check if an undervoltage trip occurs. → Change the data of function code F14 to 4 or 5.
(2) The run command stayed off even after the power recovered.	Check the input signal with Menu #4 "I/O checking" using the keypad. → Check the power recovery sequence with an external circuit. If necessary, consider the use of a relay that can keep the run command on.

6.2.2 Problems with inverter settings

[1] If the data of function codes cannot be changed

Possible Causes	What to Check and Suggested Measures
(1) An attempt was made to change function code data that cannot be changed when the inverter is running.	Check if the inverter is running with Menu #3 "Drive monitoring" using the keypad and then confirm whether the data of the function codes can be changed when the motor is running by referring to the function code tables. → Stop the motor then change the data of the function codes.
(2) The data of the function codes is protected.	Check the data of function code F00. → Disable data protection of function codes.

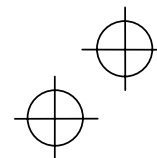
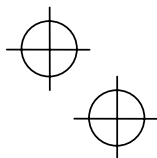

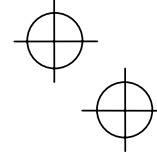
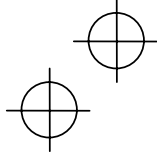

Possible Causes	What to Check and Suggested Measures
(3) The WE-KP command ("Enable editing of function codes data from keypad") is not input though it has been assigned to a digital input terminal.	Check the data of function codes E01, E02, E03, E98 and E99 and the input signals with Menu #4 "I/O checking" using the keypad. → Cancel data protection of the function codes or turn on the "Enable editing of function codes data from keypad" command.
(4) DC link circuit voltage was below the undervoltage detection level.	Check the DC link circuit voltage with Menu #5 "Maintenance information" and measure the input voltage using the keypad. → Supply power to match the inverter's input rating and change the data of the function codes.

[2] The desired menu is not displayed.

Causes	Check and Measures
(1) The limiting menu function was not selected appropriately.	Check the data of function code E52. → Change the data of function code E52 to display the desired menu.

[3] Nothing appears on the LED monitor.

Possible Causes	What to Check and Suggested Measures
(1) No power supplied to the inverter.	Check the input voltage, output voltage and interphase voltage unbalance. → Connect a molded case circuit breaker, an earth leakage circuit breaker (with the exception of those exclusively designed for protection from ground faults) or a magnetic contactor. → Check for voltage drop, phase loss, poor connections, or poor contacts, and fix them if necessary.
(2) The power for the control circuit did not reach a high enough level.	Check if the jumper bar has been removed between terminals P1 and P (+) or if there is poor contact between the jumper bar and the terminals. → Connect the jumper bar to terminals P1 and P (+) or tighten the screws. Or connect a DC reactor. → Replace the inverter if it is malfunctioning.

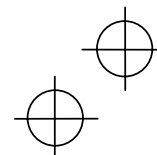
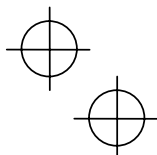

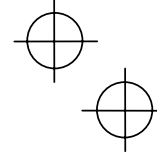
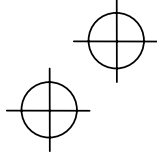

6.3 If an alarm code appears on the LED monitor

[1] OCn Overcurrent protection

Problem The inverter output current momentarily exceeded the overcurrent level.

OC1 Overcurrent occurred during acceleration.

OC2 Overcurrent occurred during deceleration.

OC3 Overcurrent occurred when running at a constant speed.

Possible Causes	What to Check and Suggested Measures
(1) The inverter output terminals were short-circuited.	Remove the wires connected to the inverter output terminals (U, V, and W) and measure the interphase resistance. Check if the resistance is too low. → Remove the part that short-circuited (including replacement of the wires, relay terminals and motor).
(2) Ground faults occurred at the inverter output terminals.	Remove the wires connected to the inverter output terminals (U, V, and W) and perform a Megger test. → Remove the part that short-circuited (including replacement of the wires, relay terminals and motor).
(3) Loads were too heavy.	Measure the motor current with a measuring device, and to trace the current trend. Therefore, use this information to judge if the trend is over the calculated load value for your system design. → If the load is too heavy, decrease it or raise the inverter capacity. Trace the current trend and check if there are any sudden changes in the current. → If there are any sudden changes, make the load variation smaller or raise the inverter capacity. → Enable current limiting (H12).
(4) The value set for torque boost (F09) was too large. (F37 = 0, 1, 3, or 4)	Check that the output current decreases and that the motor does not come to stall if you set a lower value than the current one for F09. → Lower the value for torque boost (F09) if the motor is not going to stall.
(5) The acceleration/ deceleration time was too short.	Check that the motor generates enough torque required during acceleration/deceleration. That torque is calculated from the moment of inertia for the load and the acceleration/deceleration time. → Increase the acceleration/deceleration time (F07, F08, E10, E11, and H54). → Enable current limiting (F43). → Raise the inverter capacity.
(6) Malfunction caused by noise	Check if noise control measures are appropriate (e.g., correct grounding and routing of control and main circuit wires). → Implement noise control measures. → Enable the auto-reset function (H04).

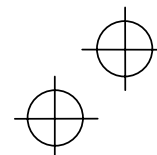
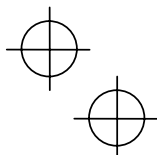

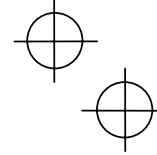
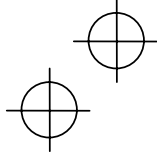

[2] OUn Overvoltage protection

Problem The DC link circuit voltage was over the detection level of overvoltage.

OU1 Overvoltage occurs during the acceleration.

OU2 Overvoltage occurs during the deceleration.

OU3 Overvoltage occurs during running at constant speed.

Possible Causes	What to Check and Suggested Measures
(1) The power supply voltage was over the range of the inverter's specifications.	Measure the input voltage. → Decrease the voltage to within that of the specifications.
(2) The acceleration time was too short.	Check if the overvoltage alarm occurs after sudden acceleration. → Increase the acceleration time (F07, E10, and H54). → Select the S-curve pattern (H07). → Consider the use of a braking resistor.
(3) The deceleration time was too short for the moment of inertia for load.	Recalculate the deceleration torque from the moment of inertia for load and the deceleration time. → Increase the deceleration time (F08, E11, and H54). → Enable automatic deceleration (H69=1) so that when the DC link circuit voltage exceeds the overvoltage suppression level, the inverter changes the deceleration time to three times longer than the set value. → Set the rated voltage (at base frequency) (F05) to 0 to improve braking ability. → Consider the use of a braking resistor.
(4) Loads were suddenly removed.	- Check if the alarm occurs when loads are suddenly removed. - Check if the inverter operation suddenly changes from driving operation to braking operation. → Consider the use of a braking resistor.
(5) Braking load was too heavy.	Compare the braking torque of the load with that of the inverter. → Set the rated voltage (at base frequency) (F05) to 0 to improve braking ability. → Consider the use of a braking resistor.
(6) Malfunction caused by noise.	Check if the DC link circuit voltage was below the protective level when the alarm occurred. → Improve noise control. → Enable the auto-reset function (H04).

[3] LU Undervoltage protection

Problem DC link circuit voltage was below the undervoltage detection level.

Possible Causes	What to Check and Suggested Measures
(1) An instantaneous power failure occurred.	→ Reset the alarm. → If you want to restart running the motor without making the alarm occur, set 4 or 5 to F14 depending on load.

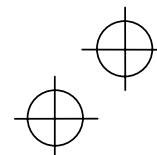
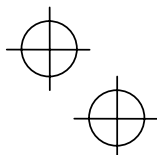

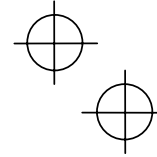
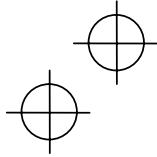

Possible Causes	What to Check and Suggested Measures
(2) The power to the inverter was switched back on too soon (with F14 = 1)	Check that you switch the inverter on after the power for the control circuit had reached an appropriate level. This can be checked using the display on the LED monitor. → Wait for a longer time than the last time before switching the inverter on.
(3) The power supply voltage did not reach the range of the inverter's specifications.	Measure the input voltage. → Increase the voltage to within that of the specifications.
(4) Peripheral equipment for the power circuit malfunctioned, or the connection was incorrect.	Measure the input voltage to find where the peripheral equipment malfunctioned or which connection is incorrect. → Replace any faulty peripheral equipment, or correct any incorrect connections.
(5) Other loads were connected to the same power system and required a large current to start running to the extent that it caused a temporary voltage drop.	Measure the input voltage and check the voltage variation. → Reconsider the power system configuration.
(6) Inrush current caused the power voltage drop because power transformer capacity was insufficient.	Check if the alarm occurs when you switch on a molded case circuit breaker, an earth leakage circuit breaker (with the exception of those exclusively designed for protection from ground faults) or a magnetic contactor. → Reconsider the capacity of the power transformer.

[4] L in Input phase loss protection

Problem Input phase loss occurred, or interphase voltage unbalance rate was large.

Possible Causes	What to Check and Suggested Measures
(1) Main circuit power input wires broken.	Measure the input voltage. → Repair or replace the wires.
(2) The terminal screws for the main circuit power input were not tight enough.	Check if the terminal screws have become loose. → Tighten the terminal screws to the recommended torque.
(3) Interphase unbalance rate of three-phase voltage was too large.	Measure the input voltage. → Connect an AC reactor (ACR) or a DC reactor (DCR) to lower the rate. → Raise the inverter capacity.
(4) Overload cyclically occurred.	Measure ripple wave of DC link circuit voltage. → If the ripple is large, raise the inverter capacity
(5) Single-phase voltage was inputted to the inverter instead of three-phase voltage input.	Check the inverter type. → Change the inverter to one for single-phase voltage input.

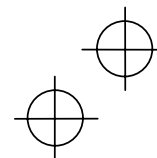
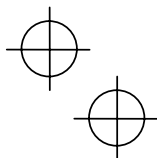

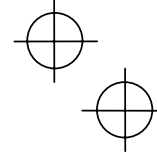
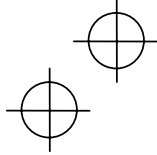

[5] OPL Output phase loss protection

Problem Output phase loss occurred.

Possible Causes	What to Check and Suggested Measures
(1) Inverter output wires are broken	Measure the output current. → Replace the output wires.
(2) Wire for motor winding are broken	Measure the output current. → Replace the motor.
(3) The terminal screws for inverter output were not tight enough.	Check if any terminal screws have become loose. → Tighten the terminal screws to the recommended torque.
(4) A single-phase motor has been connected	→ Single-phase motors cannot be used. Note that the Jaguar CUB only drives three-phase induction motors.

[6] OH1 Overheat protection for heat sink

Problem Temperature around heat sink rose.

Possible Causes	What to Check and Suggested Measures
(1) Temperature around the inverter exceeded that of inverter specifications.	Measure the temperature around the inverter. → Lower the temperature around the inverter (e.g., ventilate the enclosure well). → Reduce the load.
(2) Accumulated running time of the cooling fan exceeded the standard period for replacement, or the cooling fan malfunctioned.	Check the accumulated running time (E52=2). Refer to Chapter 3, Section 3.8 "Reading Maintenance Information." → Replace the cooling fan. Visually check that the cooling fan rotates normally. → Replace the cooling fan.
(3) Air vent is blocked.	Check if there is sufficient clearance around the inverter. → Increase the clearance. Check if the heat sink is clogged. → Clean the heat sink.
(4) Load was too heavy.	Measure the output current. → Reduce the load (e.g. reduce the load before the overload protection occurs using the overload early warning (E34)). → Decrease the carrier frequency (F26). → Enable the overload protection control (H70).

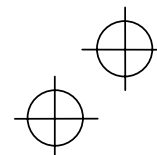
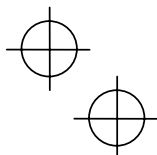

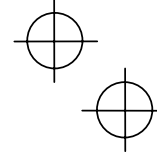
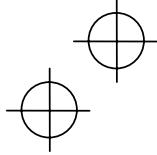

[7] OH2 External alarm input

Problem External alarm was inputted (THR).

Possible Causes	What to Check and Suggested Measures
(1) An alarm function of the external equipment was activated.	Inspect external equipment operation. → Remove the cause of the alarm that occurred.
(2) Connection has been performed incorrectly.	Check if the wire for the external alarm signal is correctly connected to the terminal to which the "Alarm from external equipment" has been assigned. → Connect the wire for the alarm signal correctly.
(3) Incorrect settings.	Check if the "Alarm from external equipment" has been assigned to an unassigned terminal. → Correct the assignment.

[8] OH4 PTC thermistor for motor protection

Problem Temperature of the motor rose abnormally.

Possible Causes	What to Check and Suggested Measures
(1) Temperature around the motor exceeded that of motor specifications.	Measure the temperature around the motor. → Decrease the temperature. → Reduce the load.
(2) Cooling system for the motor malfunctioned.	Check if the cooling system is operating normally. → Repair or replace the cooling system.
(3) Load was too heavy.	Measure the output current. → Reduce the load (e.g., reduce the load before overload occurs using the overload early warning (E34) function). → Decrease the temperature around the motor. → Increase the carrier frequency (F26).
R	Check the thermistor specifications and recalculate the detection voltage. → Reconsider the data of function code H27.
(5) A PTC thermistor and pull-up resistor were connected incorrectly or their resistance was inadequate.	Check the connections and resistance. → Correct the connections and resistance.
(6) The value set for the torque boost (F09) was too high.	Check the data of function code F09 and readjust the data so that the motor does not stall even if you set the data to a lower value. → Change the data of the function code.
(7) The V/f pattern did not match the motor.	Check if the base frequency (F04) and rated voltage (at base frequency) (F05) match the values on the nameplate on the motor. → Match the function code data to the values on the nameplate of the motor.

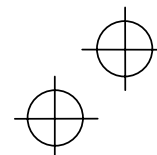
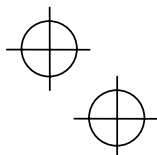

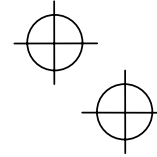
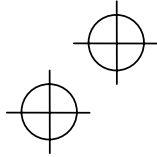

[9] *dbH* Overheat protection for braking resistor

Problem Thermal protection for braking resistor activated.

Possible Causes	What to Check and Suggested Measures
(1) Braking load was too heavy.	Recalculate the relation between the braking load and braking capacity. → Reduce the braking load. → Reconsider the braking resistor in order to improve braking ability. Resetting the data of function codes F50 and F51 is also required.
(2) The deceleration time was too short.	Recalculate the required deceleration torque and time from the moment of inertia for the load and the deceleration time. → Increase the deceleration time (F08, E11, and H54). → Reconsider the braking resistor in order to improve the braking ability. Resetting the data of function codes F50 and F51 is also required.
(3) Incorrect values have been set for the data of function codes F50 and F51.	Check the braking resistor specifications. → Reconsider and change the data of function codes F50 and F51.

NOTE: The inverter does not detect the overheating alarm of a braking resistor by monitoring its surface temperature, but by monitoring its load magnitude.

Therefore, even if the surface temperature itself does not rise, the alarm may be detected if the resistor is used more frequently than the set data of function codes F50 and F51. If you use the resistor to the limit of its capacity, you must adjust the data of function codes F50 and F51 while checking the surface temperature of the resistor.

[10] *OL1* Electronic thermal overload relay

Problem Electronic thermal function for motor overload detection activated.

Possible Causes	What to Check and Suggested Measures
(1) Load was too heavy.	Measure the output current. → Reduce the load (e.g., reduce the load before overload occurs using the overload early warning (E34)).
(2) The acceleration/ deceleration time was too short.	Check that the motor generates enough torque for acceleration/deceleration. This torque is calculated from the moment of inertia for the load and the acceleration/ deceleration time. → Increase the acceleration/ deceleration time (F07, F08, E10, E11 and H54).
(3) The characteristics of electronic thermal did not match those of the motor overload.	Check the motor characteristics. → Reconsider the data of function codes P99, F10 and F12. → Use an external thermal relay.
(4) Activation level for the electronic thermal relay was inadequate.	Check the continuous allowable current of the motor. → Reconsider and change the data of function code F11.

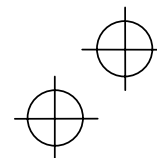
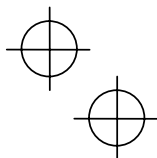

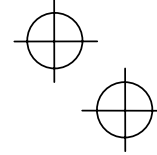
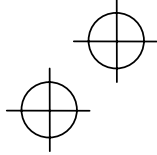

[11] OLU Overload protection

Problem Temperature inside inverter rose abnormally.

Possible Causes	What to Check and Suggested Measures
(1) Temperature around the inverter exceeded that of inverter specifications.	Measure the temperature around the inverter. → Lower the temperature (e.g., ventilate the enclosure well). → Reduce the load.
(2) The service life of the cooling fan has expired or the cooling fan malfunctioned.	Check the accumulated running time of cooling fan (E52=2). Refer to Chapter 3, Section 3.8 "Reading Maintenance Information." → Replace the cooling fan. Visually check that the cooling fan rotates normally. → Replace the cooling fan.
(3) Air vent is blocked.	Check if there is sufficient clearance around the inverter. → Increase the clearance. Check if the heat sink is clogged. → Clean the heat sink.
(4) Load was too heavy.	Measure the output current. → Reduce the load (e.g., reduce the load before overload occurs using the overload early warning (E34)). → Decrease the carrier frequency (F26). → Enable overload protection control (H70).
(5) The acceleration/ deceleration time was too short.	Recalculate the required acceleration/deceleration torque and time from the moment of inertia for the load and the deceleration time. → Increase the acceleration/deceleration time (F07, F08, E10, E11 and H54).
(6) The wires to the motor are too long and caused a large amount of current to leak from them.	Measure the leak current. → Connect an output circuit filter (OFL).

[12] Er1 Memory error

Problem Error occurred in writing the data to the memory in the inverter.

Possible Causes	What to Check and Suggested Measures
(1) The power supply was turned off when the inverter was writing data (especially initializing data), and the remaining control circuit voltage was not high enough to enable writing of data.	Check if pressing the  key resets the alarm after the function code data are initialized by setting the data of H03 to 1. → Return the initialized function code data to their previous settings, then restart the operation.

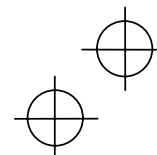
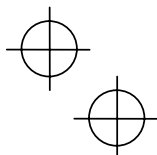

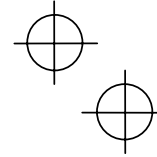
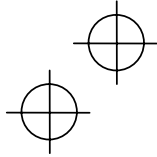

Possible Causes	What to Check and Suggested Measures
(2) A high intensity noise was given to the inverter while data (especially initializing data) was being written.	<p>Check if appropriate noise control measures have been implemented (e.g., correct grounding and routing of control and main circuit wires). Alternatively, perform the same check as described in (1) above.</p> <p>→ Improve noise control. Alternatively, return the initialized function code data to their previous settings, then restart the operation.</p>
(3) The CPU did not operate normally.	<p>Initialize the function code data by setting H03 to 1, then reset the alarm by pressing the  key and check that the alarm goes on.</p> <p>→ This problem was caused by a printed circuit board (PCB) (including the CPU) malfunction, so it is necessary to replace the PCB. Contact IMO.</p>

[13] *Er2* Remote keypad communications error

Problem A communications error occurred between the remote keypad and the inverter.

Possible Causes	What to Check and Suggested Measures
(1) Break in the communications cable or poor contact.	<p>Check continuity of the cable, contacts and connections.</p> <p>→ Replace the cable.</p>
(2) A high intensity noise was given to the inverter.	<p>Check if appropriate noise control measures have been implemented (e.g., correct grounding and routing of control and main circuit wires).</p> <p>→ Improve noise control.</p>
(3) The remote keypad malfunctioned.	<p>Check that alarm <i>Er2</i> does not occur if you connect another remote keypad to the inverter.</p> <p>→ Replace the remote keypad.</p>
(4) The RS485 communications card malfunctioned.	<p>Check that alarm <i>Er2</i> does not occur even if you connect another remote keypad to the inverter.</p> <p>→ Replace the card.</p>

[14] *Er3* CPU error

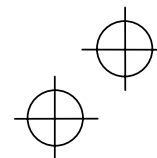
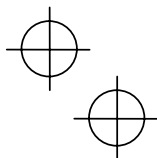

Problem A CPU error (e.g. erratic CPU operation) occurred.

Causes	What to Check and Suggested Measures
(1) A high intensity noise was given to the inverter.	<p>Check if appropriate noise control measures have been implemented (e.g. correct grounding and routing of control and main circuit wires).</p> <p>→ Improve noise control.</p>
(2) The printed control circuit board in the inverter malfunctioned.	<p>→ Contact IMO.</p>



[15] Er6 Operation protection

Problem An error occurred due to incorrect operation of the motor.

Possible Causes	What to Check and Suggested Measures
(1) The  key was pressed when H96 = 1 or 3.	<ul style="list-style-type: none"> ➔ Change the setting for H96 so that the STOP key priority function is invalid to ensure that the inverter does not operate unexpectedly.
(2) The start check function was activated when H96 = 2 or 3.	<p>Check that Er6 occurs when:</p> <ul style="list-style-type: none"> - The power is switched on - An alarm is released (by pressing the  key or turning reset alarm (RST) on) - The link command (LE) has switched the inverter operations. <ul style="list-style-type: none"> ➔ Reconsider the running sequence to avoid input of the run command when Er6 has occurred. ➔ Change the setting for H96 so that the STOP key priority function is invalid to ensure the inverter does not operate unexpectedly. <p>(To reset the alarm, turn the run command off.)</p>

[16] Er8 RS485 communications error

Problem A communications error occurred during RS485 communications.

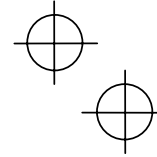
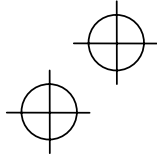

Possible Causes	What to Check and Suggested Measures
(1) Host controllers (e.g., PLCs and personal computers) did not operate due to incorrect settings and/or defective software/hardware.	<p>Check the controllers.</p> <ul style="list-style-type: none"> ➔ Remove the cause of the controller error.
(2) Relay converters (e.g., RS232C/RS485 converter) did not operate due to incorrect connections and settings, and defective hardware.	<p>Check the converter (e.g., check for poor contact).</p> <ul style="list-style-type: none"> ➔ Change the various converter settings, reconnect the wires, or replace hardware (such as recommended devices) as appropriate.
(3) Broken communications cable or poor contact.	<p>Check continuity of the cable, contacts and connections.</p> <ul style="list-style-type: none"> ➔ Replace the cable.
(4) Even though no response error detection time (y08) has been set, communications did not occur cyclically.	<p>Check the host controllers.</p> <ul style="list-style-type: none"> ➔ Change the settings of host controller software, or make the no response error detection time invalid (y08=0).
(5) A high intensity noise was given to the inverter.	<p>Check if appropriate noise control measures have been implemented (e.g., correct grounding and routing of control and main circuit wires).</p> <ul style="list-style-type: none"> ➔ Improve noise control. ➔ Improve measures against noise from host controllers. ➔ Replace the relay converter with a recommended insulated converter.



Possible Causes	What to Check and Suggested Measures
(6) Conditions for communications differ between the inverter and host controllers.	Compare the settings of the y codes (y01 to y10) with those of the host controllers. → Correct any settings which differ.
(7) The RS485 communications card malfunctioned.	→ Replace the card.

[17] ErrF Data save error during undervoltage

Problem The inverter was unable to save data such as the frequency commands, timer, and PID process commands set through the keypad when the power was switched off.

Possible Causes	What to Check and Suggested Measures
(1) The control circuit voltage dropped suddenly while the data was being saved when the power was turned off, because the electric charge in the DC bus capacitor was rapidly discharged.	Check how long it takes for the DC link circuit voltage to drop to the preset voltage when the power is turned off. → Remove whatever is causing the rapid discharge of the electric charge. After pressing the  key and releasing the alarm, reset the data (such as the frequency commands, timer, and PID process commands) set with the keypad to the correct settings and then restart the motor.
(2) A high intensity noise was given to the inverter while data was being written when the power was turned off.	Check if appropriate noise control measures have been implemented (e.g., correct grounding and routing of control and main circuit wires). → Improve noise control. Press the  key to release the alarm, then reset the data (e.g., frequency commands, timer, and PID process commands) set through the keypad to the correct settings. Restart the motor.
(3) The CPU did not operate normally.	Check if ErrF occurs each time the power is switched off. → This problem was caused by a printed circuit board (PCB) (including the CPU) malfunction, so it is necessary to replace the PCB. Contact IMO.

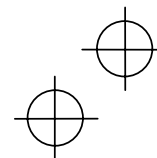
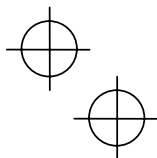

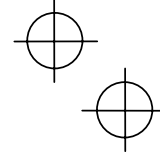
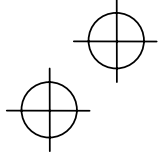

Chapter 7 MAINTENANCE AND INSPECTION

Perform daily and periodic inspection to avoid trouble and keep reliable operation for a long time. Take care of the following items during work.

WARNING

- The electric charge in the DC bus capacitor will be retained even after the power is turned off. Therefore, it may take a long time until the DC link circuit voltage reaches a safe potential. Do not open the control circuit terminal block cover within 5 minutes after the power has been turned off. Then remove the control circuit and main circuit terminal block covers. Check that the DC link circuit voltage between main circuit terminals P (+) and N (-) does not exceed the safety voltage (+25 VDC) with a multimeter and start the maintenance and inspection.

Electric shock may occur.

- Maintenance, inspection, and parts replacement should be made only by authorized persons.
- Take off watches, rings and other metallic matter before starting work.
- Use insulated tools.
- Never attempt to repair the Inverter.

Electric shock or injuries could occur.

7.1 Daily Inspection

Visually inspect errors in the state of operation from the outside without removing the covers while the inverter operates or while it is turned on.

- Check if the expected performance (satisfying the standard specification) is obtained.
- Check if the surrounding environment satisfies Chapter 2, Section 2.1 "Operating Environment."
- Check that the LED monitor displays normally.
- Check for abnormal noise, odour, or excessive vibration.
- Check for traces of overheat, discoloration and other defects.

7.2 Periodic Inspection

Perform periodic inspection by following the items of the list of periodic inspection in Table 7.1. Stop the motor, turn the inverter off and remove the control and main circuit terminal block covers to perform periodic inspection.

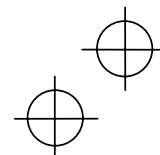
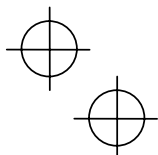

Table 7.1 List of Periodic Inspections

Check part	Check item	How to inspect	Evaluation criteria	
Environment	<ol style="list-style-type: none"> 1) Check the ambient temperature, humidity, vibration and atmosphere (dust, gas, oil mist, or water drops). 2) Check if tools or other foreign matter or dangerous objects are left around the equipment. 	<ol style="list-style-type: none"> 1) Check visually or measure using apparatus. 2) Visual inspection 	<ol style="list-style-type: none"> 1) The standard specification must be satisfied. 2) No foreign or dangerous objects are left. 	
Voltage	Check if the voltages of the main and control circuit are correct.	Measure the voltages using a multimeter or the like.	The standard specification must be satisfied.	
Keypad	<ol style="list-style-type: none"> 1) Check if the display is clear. 2) Check if there is missing parts in the characters. 	<ol style="list-style-type: none"> 1), 2) Visual inspection 	<ol style="list-style-type: none"> 1), 2) The display can be read and there is no fault. 	
Structure such as frame and cover	<ol style="list-style-type: none"> 1) Abnormal noise and excessive vibration 2) Loosen bolts (tightened parts) 3) Deformation and breakage 4) Discoloration and deformation caused by overheat 5) Check for debris and dust. 	<ol style="list-style-type: none"> 1) Visual or hearing inspection 2) Retighten. 3), 4), 5) Visual inspection 	<ol style="list-style-type: none"> 1), 2), 3), 4), 5) No abnormalities 	
Main circuit	Common	<ol style="list-style-type: none"> 1) Check if bolts and screws are tight and not missing. 2) Check the devices and insulators for deformation, cracks, breakage and discoloration caused by overheat and deterioration. 3) Check for debris and dust. 	<ol style="list-style-type: none"> 1) Retighten. 2), 3) Visual inspection 	<ol style="list-style-type: none"> 1), 2), 3) No abnormalities
	Conductor and wire	<ol style="list-style-type: none"> 1) Check the conductor for discoloration and distortion caused by overheat. 2) Check the sheath of the cable for cracks and discoloration. 	<ol style="list-style-type: none"> 1), 2) Visual inspection 	<ol style="list-style-type: none"> 1), 2) No abnormalities
	Terminal block	Check that the terminals are not damaged.	Visual inspection	No abnormalities

Table 7.1 Continued

	Check part	Check item	How to inspect	Evaluation criteria
Main circuit	Filtering capacitor (Note 1)	1) Check for electrolyte leakage, discoloration, cracks and swelling of the case. 2) Check if the safety valve does not protrude excessively 3) Measure the capacitance if necessary.	1),2) Visual inspection 3) Measure discharge time with capacitance probe.	1),2) No abnormalities 3) The discharge time is not shorter than time specified by the replacement manual.
	Braking resistor	1) Check for odor caused by overheat and cracked insulator. 2) Check for broken wire.	1) Smelling and visual inspection 2) Visual inspection or measurement with multimeter under disconnection of one lead	1) No abnormalities 2) Within $\pm 10\%$ of displayed resistance
	Transformer and reactor	Check for abnormal noise and odor.	Hearing, visual and smelling inspection	No abnormalities
	Magnetic contactor and relay	1) Check for chatters during operation. 2) Check for rough contacts.	1) Hearing inspection 2) Visual inspection	1), 2) No abnormalities
Control circuit	Printed circuit board (Note 1)	1) Check for loose screws and connectors. 2) Check for odor and discoloration. 3) Check for cracks, breakage, deformation and excessive rust. 4) Check the capacitors for electrolyte leaks and deformation.	1) Retighten. 2) Smelling and visual inspection 3), 4) Visual inspection	1), 2), 3), 4) No abnormalities
Cooling system	Cooling fan (Note 1)	1) Check for abnormal noise and excessive vibration. 2) Check for loose bolts. 3) Check for discoloration caused by overheat.	1) Hearing and visual inspection, or turn manually (be sure to turn the power off). 2) Retighten. 3) Visual inspection	1) Smooth rotation 2), 3) No abnormalities
	Ventilation path	Check the heat sink, intake and exhaust ports for clogging and foreign matter.	Visual inspection	No abnormalities

(Note 1) The judgement level of part replacement period with Menu #5 "Maintenance information" should be used as a guide. Determine the replacement period on the basis of the standard replacement years. (See Section 7.5 "List of Periodical Replacement Parts.")

If the inverter is stained, wipe it off with a chemically neutral cloth to remove dust, use a vacuum cleaner.

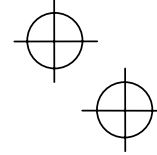
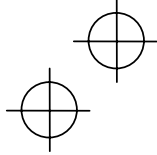

■ Judgement of service life using maintenance information

Menu #5 "Maintenance information" in Programming mode can be used to display data for the judgement of replacement of "DC bus capacitor," "electrolytic capacitor on the printed circuit board," and "cooling fan" as a guide.

If the replacement data is out of the judgement level for early warning, an early warning signal is output to an external device through terminal [Y1] (function code E20). (When any replacement data is out of the judgement level, terminal [Y1] outputs ON signal.)

Table 7.2 Parts Replacement Judgement with Menu #5 "Maintenance Information"

Parts to be replaced	Judgement level
DC bus capacitor	85% or lower of the capacitance than that of the factory setting
Electrolytic capacitor on the printed circuit board	61,000 hours or longer as accumulated run time
Cooling fan (Applicable motor rating: 1.5 to 4.0 kW)	61,000 hours or longer as accumulated run time (Assumed life of cooling fan at ambient inverter temperature of 40°C)

(1) DC bus capacitor

Measure the capacitance of the DC bus capacitor as follows:

The capacitance is displayed in the reduction ratio (%) of the initial value written in the inverter memory before shipment.

----- Capacitance measurement procedure -----

- 1) Remove the RS485 communications card (option) from the inverter if it is mounted. Disconnect the DC bus link circuit to other inverters from terminals P (+) and N (-) of the main circuit if any. A DC reactor (option) and braking resistor (option) may not be disconnected. Keep the ambient temperature at $25 \pm 10^\circ\text{C}$.
- 2) Turn off the digital inputs (FWD, REV, and X1 to X3) at the control terminals.
 - If an external potentiometer is connected, to terminal [13], remove it.
 - Set the data of function codes E20 and E27 as the transistor output [Y1] or relay output [30A, B, C] does not come on while the inverter power is turned off. E.g., recommended settings are to assign normal logic signal (RUN) and (ALM) to terminals [Y1] and [30A, B, C] respectively.
- 3) Turn the inverter power on.
- 4) Check that the cooling fan rotates and the inverter is on halt.
- 5) Turn the main power supply off. Start measuring the capacitance of the DC bus capacitor.
- 6) After the LED monitor is unlit completely, turn the main power supply on again.
- 7) Select Menu #5 "Maintenance information" in Programming mode, and check the reduction ratio (%) of the capacitance of the DC bus capacitor.

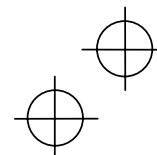
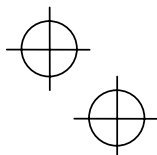

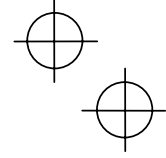
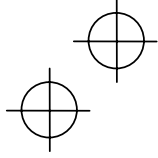

(2) Electrolytic capacitor on the printed circuit board

The inverter keeps an accumulative total of the number of hours that power has been applied to the control circuit and displays it on the LED monitor. Use this to determine when the capacitor should be replaced. The display is in units of 1000 hours.

(3) Cooling fan

The inverter accumulates hours for which the cooling fan has run. The display is in units of 1000 hours.

The accumulated time should be used just a guide since the actual service life will be significantly affected by the temperature and operation environment.

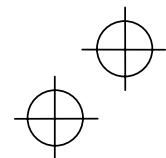
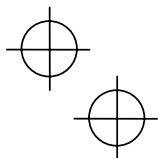

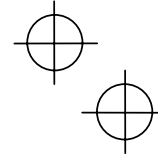
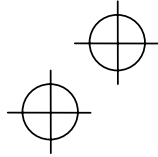

7.3 Measurement of Electrical Amounts in Main Circuit

Because the voltage and current of the power supply (input) of the main circuit of the inverter and the output (motor) include harmonic components, the indicated value deviates according to the type of the meter. Use meters indicated in Table 7.3 when measuring with meters for commercial frequencies.

The power factor cannot be measured by a commercially available power-factor meter that measures the phase difference between the voltage and current. To obtain the power factor, measure the power, voltage and current on each of the input and output sides and calculate in the following formula.

■ Three-phase input

■ Single-phase input

$$\text{Power factor} = \frac{\text{Electric power (W)}}{\sqrt{3} \times \text{Voltage (V)} \times \text{Current (A)}} \times 100 \% \quad \text{Power factor} = \frac{\text{Electric power (W)}}{\text{Voltage (V)} \times \text{Current (A)}} \times 100 \%$$

Table 7.3 Meters for Measurement of Main Circuit

Item	Input (power supply) side			Output (motor) side			DC link circuit voltage (P (+)-N (-))
Waveform	Voltage 		Current 	Voltage 	Current 		
Name of meter	Ammeter AR, AS, AT	Voltmeter VR, VS, VT	Wattmeter WR, WT	Ammeter AU, AV, AW	Voltmeter VU, VV, VW	Wattmeter WU, WW	DC voltmeter V
Type of meter	Moving iron type	Rectifier or moving iron type	Digital power meter	Digital power meter	Digital power meter	Digital power meter	Moving coil type
Symbol of meter			—	—	—	—	

Note When the output voltage is measured by a rectifier type voltmeter, an error may be included or the voltmeter might be burn out. To measure it with higher accuracy, use a digital AC power meter.

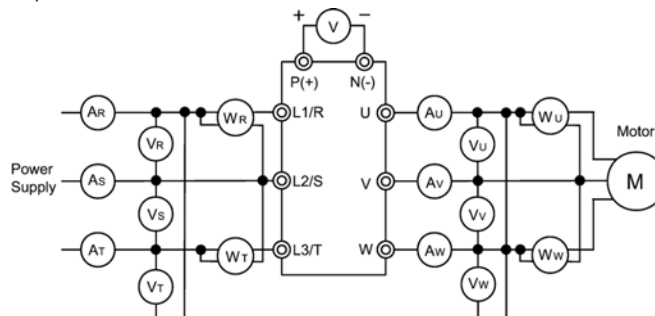
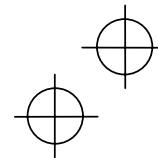
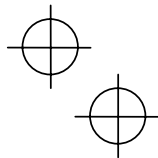
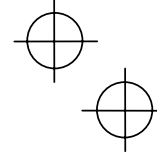
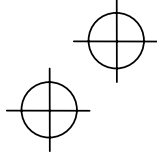

Figure 7.1 Connection of Meters





7.4 Insulation Test

Because an insulation test is made in the factory before shipment, avoid a Megger test.

If a Megger test is unavoidable, follow the procedure below. Because a wrong test procedure will cause breakage of the inverter, take sufficient care.

A dielectric strength test will cause breakage of the inverter similarly to the Megger test if the test procedure is wrong. When the dielectric strength test is necessary, contact the Company where you purchased the product or contact IMO.

(1) Megger test of main circuit

- 1) Use a 500 VDC Megger and shut off the main power supply without fail during measurement.
- 2) If the test voltage leaks to the control circuit due to the wiring, disconnect all the control wiring.
- 3) Connect the main circuit terminals with a common cable as shown in Figure 7.2.
- 4) The Megger test must be limited to across the common line of the main circuit and the ground terminal (G).
- 5) 5 M Ω (1 M Ω for the EMC filter built-in type of inverters) or a larger value displayed at the Megger indicates a correct state. (The value is for a discrete inverter.)

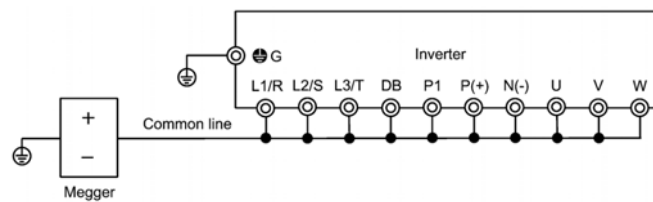

Figure 7.2 Megger Test

(2) Dielectric strength test of control circuit

Do not perform a Megger test or dielectric strength test for the control circuit. Prepare a high resistance range tester for the control circuit.

- 1) Disconnect all the external wiring from the control circuit terminals.
- 2) Perform a continuity test to the ground. 1 M Ω or a larger measurement indicates a correct state.

(3) Dielectric strength test of external main circuit and sequence control circuit

Disconnect all the inverter terminals so that the test voltage is not applied.

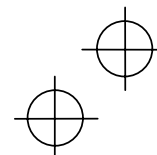
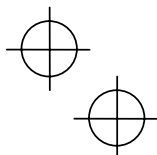

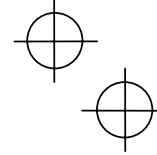
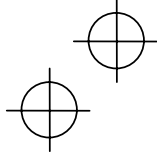

7.5 List of Periodical Replacement Parts

Each part of the product has its own service life that will vary according to the environmental and operating conditions. It is recommended that the following parts be replaced as specified below.

When the replacement is necessary, contact your dealer where you purchased the product or IMO.

Table 7.4 Replacement Parts

Part name	Standard replacement intervals
Cooling fan	5 years
DC bus capacitor	5 years
Electrolytic capacitor on the printed circuit board	7 years

7.6 Inquiries about Product and Guarantee

(1) When making an inquiry

Upon breakage of the product, uncertainties, failure or inquiries, report the following information to the Company where you purchased the product or contact IMO

- 1) Inverter type
- 2) SER No. (serial number of equipment)
- 3) Function codes and their data that you changed
- 4) ROM version
- 5) Date of purchase
- 6) Inquiries (for example, point and extent of breakage, uncertainties, failure phenomena, and other circumstances)

(2) Guarantee of the product

The product warranty term is five years from date of dispatch from IMO. Warranty is void if drive fails due to the following conditions:

- 1) The cause includes incorrect usage or inappropriate repairs or remodeling.
- 2) The product is used outside the standard specified range.
- 3) The failure is caused by dropping, damage or breakage during transportation after the purchase.
- 4) The cause is earthquake, fire, storm or flood, lightning, excessive voltage, or other types of disaster or secondary disasters.

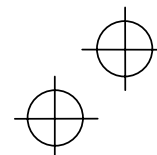
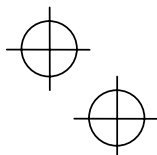

Chapter 8 SPECIFICATIONS

8.1 Standard Models

8.1.1 Three-phase 200 V Series

Item	Specifications				
Power supply voltage	Three-phase 200 V				
Type (CUB ₋₋₋)	3A-2	5A-2	8A-2	11A-2	17A-2
Applicable motor rating (kW) *1	0.4	0.75	1.5	2.2	4.0
Rated capacity (kVA) *2	1.1	1.9	3.0	4.2	6.5
Rated voltage (V) *3	Three-phase, 200 V/50 Hz, 200 V, 220 V, 230 V/60 Hz				
Rated current (A) *4	3.0 (2.5)	5.0 (4.2)	8.0 (7.0)	11.0 (10.0)	17.0 (16.5)
Overload capability	150 % of rated output current for 1 min. 200 % of rated output current for 0.5 s				
Rated frequency (Hz)	50, 60 Hz				
Phases, voltage, frequency	Three-phase, 200 to 240 V, 50/60 Hz				
Voltage and frequency variations	Voltage : +10 to -15 % (Interphase voltage unbalance*5: 2 % or less) Frequency: +5 to -5 %				
Momentary voltage dip capability *6	When the input voltage is 165 V or more, the inverter may keep running. Even if it drops below 165 V, the inverter may keep running for 15 ms.				
Rated current (A) *7	(w/ DCR) 3.1	3.0 5.3	5.7 9.5	8.3 13.2	14.0 22.2
Required power supply capacity (kVA) *8	0.6	1.1	2.0	2.9	4.9
Torque (%) *9	100		50	30	
Torque (%) *10	150				
DC injection braking	Starting frequency: 0.0 to 60.0 Hz Braking time: 0.0 to 30.0 s Braking level: 0 to 100 % of rated current				
Enclosure (IEC60529)	IP20, UL open type *11				
Cooling method	Natural cooling			Fan cooling	
Weight (kg)	0.6	0.7	1.7	1.7	2.3

*1 4-pole standard

*2 The rated capacity is for 220V output voltage.

*3 Output voltages cannot exceed the power supply voltage.

*4 Use the inverter at the current given in () or below when the carrier frequency command is higher than 4 kHz ($F_{26} = 4$ to 15) or the ambient temperature is 40°C or higher.

*5 Interphase voltage unbalance (%) = $\frac{\text{Max. voltage (V)} - \text{Min. voltage (V)}}{3\text{-phase average voltage (V)}} \times 67$ (Refer to IEC 61800 - 3 (5.2.3))

If this value is 2 to 3 %, use an AC reactor (ACR).

*6 Tested under the standard load condition (85% load for applicable motor rating).

*7 Calculated under specified conditions.

*8 Indicates the value when using a DC reactor (option).

*9 Average braking torque obtained with the AVR control off ($F_{05} = 0$). (Varies according to the efficiency of the motor.)

*10 Average braking torque obtained by use of an external braking resistor (standard type available as option).

*11 To make Jaguar CUB compliant with category TYPE1 of the UL Standard, Note that the TYPE1-compliant Jaguar CUB should be used in the ambient temperature range from -10 to +40°C.

Note: A box (□) in the above table replaces the E suffix for filtered version.

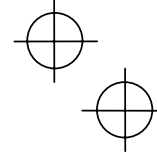
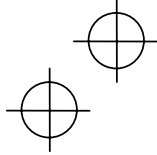

8.1.2 Three-phase 400 V Series

Item		Specifications					
Power supply voltage		Three-phase 400 V					
Type (CUB _ _ _)		1A5-4	2A5-4	3A7-4	5A5-4	9A-4	
Applicable motor rating (kW) *1		0.4	0.75	1.5	2.2	4.0	
Output Ratings	Rated capacity (kVA) *2	1.1	1.9	2.8	4.1	6.8	
	Rated voltage (V) *3	Three-phase, 380, 400, 415 V/50 Hz, 380, 400, 440, 460 V/60 Hz					
	Rated current (A)	1.5	2.5	3.7	5.5	9.0	
	Overload capability	150 % of rated output current for 1 min. 200 % of rated output current for 0.5 s					
Rated frequency (Hz)		50, 60 Hz					
Phases, voltage, frequency		Three-phase, 380 to 480 V, 50/60 Hz					
Input Ratings	Voltage and frequency variations	Voltage : +10 to -15 % (Interphase voltage unbalance*4; 2 % or less) Frequency: +5 to -5 %					
	Momentary voltage dip capability *5	When the input voltage is 300 V or more, the inverter may keep running. Even if it drops below 300 V, the inverter may keep running for 15 ms.					
	Rated current (A) *6	(w/ DCR)	0.85	1.6	3.0	4.4	7.3
		(w/o DCR)	1.7	3.1	5.9	8.2	13.0
Required power supply capacity (kVA) *7		0.6	1.1	2.0	2.9	4.9	
Torque (%) *8		100		50	30		
Torque (%) *9		150					
DC injection braking		Starting frequency: 0.0 to 60.0 Hz Braking time: 0.0 to 30.0 s Braking level: 0 to 100 % of rated current					
Enclosure (IEC60529)		IP20, UL open type *10					
Cooling method		Natural cooling			Fan cooling		
Weight (kg)		1.1	1.2	1.7	1.7	2.3	

*1 4-pole standard

*2 The rated capacity is for 440V output voltage.

*3 Output voltages cannot exceed the power supply voltage.

*4 Interphase voltage unbalance (%) = $\frac{\text{Max.voltage (V)} - \text{Min.voltage (V)}}{3\text{-phase average voltage (V)}} \times 67$ (Refer to IEC 61800-3 (5.2.3))

If this value is 2 to 3 %, use an AC reactor (ACR).

*5 Tested under the standard load condition (85% load for applicable motor rating).

*6 Calculated under specified conditions.

*7 Indicates the value when using a DC reactor (option).

*8 Average braking torque obtained with the AVR control off ($F_{05} = 0$). (Varies according to the efficiency of the motor.)

*9 Average braking torque obtained by use of an external braking resistor (standard type available as option).

*10 To make Jaguar CUB compliant with category TYPE1 of the UL Standard, Note that the TYPE1-compliant Jaguar CUB should be used in the ambient temperature range from -10 to +40°C.

Note: A box (□) in the above table replaces the E suffix for filtered version.

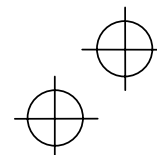
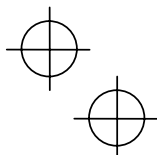

8.1.3 Single-phase 200 V Series

Item		Specifications				
Power supply voltage		Single-phase 200 V				
Type (CUB _ _ _)		3A-1	5A-1	8A-1	11A-1	
Applicable motor rating (kW) *1		0.4	0.75	1.5	2.2	
Rated capacity (kVA) *2		1.1	1.9	3.0	4.1	
Output Ratings	Rated voltage (V) *3	Three-phase, 200 V/50 Hz, 200 V, 220 V, 230 V/60 Hz				
	Rated current (A) *4	3.0 (2.5)	5.0 (4.2)	8.0 (7.0)	11.0 (10.0)	
	Overload capability	150 % of rated output current for 1 min. 200 % of rated output current for 0.5 s				
	Rated frequency (Hz)	50, 60 Hz				
Phases, voltage, frequency		Single-phase, 200 to 240 V, 50/60 Hz				
Voltage and frequency variations		Voltage : +10 to -10 % Frequency: +5 to -5 %				
Momentary voltage dip capability *5		When the input voltage is 165 V or more, the inverter may keep running. Even if it drops below 165 V, the inverter may keep running for 15 ms.				
Input Ratings	Rated current (A) *6	(w/ DCR)	3.5	6.4	11.6	17.5
		(w/o DCR)	5.4	9.7	16.4	24.8
	Required power supply capacity (kVA) *7	0.7	1.3	2.4	3.5	
Braking	Torque (%) *8	100				
	Torque (%) *9	150				
	DC injection braking	Starting frequency: 0.0 to 60.0 Hz Braking time: 0.0 to 30.0 s Braking level: 0 to 100 % of rated current				
Enclosure (IEC60529)		IP20, UL open type *10				
Cooling method		Natural cooling		Fan cooling		
Weight (kg)		0.6	0.8	1.7	2.3	

*1 4-pole standard

*2 The rated capacity is for 220V output voltage.

*3 Output voltages cannot exceed the power supply voltage.

*4 Use the inverter at the current given in () or below when the carrier frequency command is higher than 4 kHz ($F_{26}=4$ to 15) or the ambient temperature is 40°C or higher.

*5 Tested under the standard load condition (85% load for applicable motor rating).

*6 Calculated under specified conditions.

*7 Indicates the value when using a DC reactor (option).

*8 Average braking torque obtained with the AVR control off ($F_{05}=0$). (Varies according to the efficiency of the motor.)

*9 Average braking torque obtained by use of an external braking resistor (standard type available as option).

*10 To make Jaguar CUB compliant with category TYPE1 of the UL Standard. Note that the TYPE1-compliant Jaguar CUB should be used in the ambient temperature range from -10 to +40°C.

Note: A box (□) in the above table replaces the E suffix for filtered version.

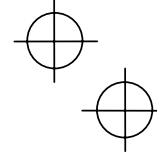
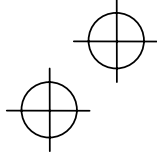

8.2 Models Available on Order

8.2.1 EMC Filter Built-in Type

■ Three-Phase 200 and 400 V Series

Item	Specifications									
	Three-phase 200 V					Three-phase 400 V				
Power supply voltage										
Type (CUB _ _ _)	3A-2E	5A-2E	8A-2E	11A-2E	17A-2E	1A5-4E	2A5-4E	3A7-4E	5A5-4E	9A-4E
Applicable motor rating (kW) *1	0.4	0.75	1.5	2.2	4.0	0.4	0.75	1.5	2.2	4.0
Weight (kg)	0.7	0.8	2.4	2.4	2.9	1.5	1.6	2.5	2.5	3.0

*1 4-pole standard

Note 1: An asterisk (*) in the above table replaces numbers which denote the following:
 2: three-Phase 200 V, 4: three-Phase 400 V

Note 2: A box (□) in the above table replaces the E suffix for the filtered version.

Other than those items in the above table are the same as those in Section 8.1 "Standard Models."

■ Single-phase 200 V Series

Item	Specifications			
	Single-phase 200 V			
Power supply voltage				
Type (CUB _ _ _)	3A-1E	5A-1E	8A-1E	11A-1E
Applicable motor rating (kW) *1	0.4	0.75	1.5	2.2
Weight (kg)	0.7	1.2	2.4	2.9

*1 4-pole standard

Note 1: A box (□) in the above table replaces the E suffix for the filtered version.

Other than those items in the above table are the same as those in Section 8.1 "Standard Models."

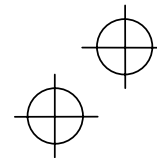
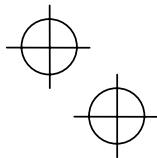

8.3 Common Specifications

	Item	Detail specifications
Output frequency	Setting range	Maximum frequency: 25 to 400 Hz Base frequency: 25 to 400 Hz Starting frequency: 0.1 to 60.0 Hz Carrier frequency: 0.75 k to 15 kHz Frequency may drop automatically to protect the inverter running at 7 kHz or more. This protective operation can be cancelled by function code H98.
	Accuracy (Stability)	Analog setting: $\pm 0.2\%$ of maximum frequency (at $25 \pm 10^\circ\text{C}$) Digital setting: $\pm 0.01\%$ of maximum frequency (at -10 to $+50^\circ\text{C}$)
	Setting resolution	Analog setting: $1/1000$ of maximum frequency (e.g. 0.06 Hz at 60 Hz, 0.4 Hz at 400 Hz) (Includes the built-in potentiometer on the keypad.) Keypad setting: 0.01 Hz (99.99 Hz or less), 0.1 Hz (100.0 Hz or more) (Setting with Δ , ∇ keys.) Link setting: Selectable from 2 types • $1/20000$ of maximum frequency (e.g. 0.003 Hz at 60 Hz, 0.02 Hz at 400 Hz) • 0.01 Hz (fixed)
	Control method	V/f control (Simplified torque-vector control)
	Voltage/frequency characteristics	• Possible to set output voltage at base frequency and at maximum frequency (common specifications). Three-phase 200 V, single-phase 200 V: 80 to 240 V Three-phase 400 V: 160 to 500 V • AVR control can be turned ON or OFF (Factory setting: OFF). (Non-linear V/f pattern) 1 point (Desired voltage and frequency can be set.)
Control	Torque boost	Torque boost can be set with the function code F09. (Sets when 0, 1, 3, or 4 is selected at F37.)
	(Load selection)	Select application load type with the function code F37. 0: Torque inversely proportional to the square of speed 1: Constant torque load 2: Auto-torque boost 3: Auto-energy saving operation (Torque inversely proportional to the square of speed in acceleration/deceleration) 4: Auto-energy saving operation (Constant torque load in acceleration/deceleration) 5: Auto-energy saving operation (Auto-torque boost in acceleration/deceleration)
	Starting torque	150% or more (Automatic torque boost in 5 Hz operation)
Control	Start/stop	Keypad operation: Start (FWD/REV) and stop with RUN and STOP keys (Remote keypad (available soon) is also usable.) External signal (digital input): FWD, REV, coast-to-stop command, etc. Link operation: Communication via RS485 (RS485 communications functions are optional.)
	Frequency setting	• Can be set with built-in potentiometer (standard) • Can be set with Δ or ∇ key (Remote keypad (available soon) is also usable.) Can be set with external potentiometer (1 to 5 k Ω) • Connected to analog input terminals 13, 12, and 11. • Potentiometer must be provided. • Analog input • Can be set with external voltage/current output • 0 to +10 VDC (0 to +5 VDC)/0 to 100 % (terminal 12) • +4 to +20 mA DC /0 to 100 % (terminal C1) (Inverse mode operation) • Can be reversed with digital input signal (IVS) • +10 to 0 VDC (+5 to 0 VDC)/0 to 100 % (terminal 12) • +20 to +4 mA DC/0 to 100 % (terminal C1) • Multi-step frequency: Selectable from 8 steps (step 0 to 7) • Link operation: Can be set with communication via RS485 (RS485 communications functions are optional.)

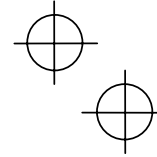
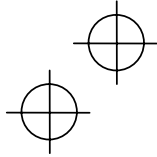

Item	Detail specifications																						
Control	Running status signal	<ul style="list-style-type: none"> • Transistor output (1 point) : RUN, FAR, FDT, LU, etc. • Relay output (1 point) : Alarm relay output or multi-purpose relay output signal • Analog output (1 point) : Output frequency, output current, output voltage, input power, etc. 																					
	Acceleration/ deceleration time	0.00 to 3600 s * If 0.00 s is set, the time setting is cancelled and acceleration and deceleration is made according to the pattern given with an external signal.																					
	(Pattern)	Acceleration and deceleration time can be independently set and selected with digital input signal (1 point). Acceleration and deceleration pattern can be selected from 4 types: Linear, S-curve (weak), S-curve (strong), Curvilinear																					
Various functions	Frequency limiter (upper and lower limiters), Bias frequency, Gain for frequency command, Jump frequency control, Jogging operation, Timer operation, Auto-restart after instantaneous power failure, Slip compensation, Current limit, PID control, Automatic deceleration, Overload prevention control, Energy saving operation, Fan stop operation																						
Indication	Running	<ul style="list-style-type: none"> • Speed monitor, output current (A), output voltage (V), input power (kW), PID process command, PID feedback amount, Timer (sec) • Select the speed monitor to be displayed from the following: • Output frequency (before slip compensation) (Hz), output frequency (after slip compensation) (Hz), set frequency (Hz), load shaft speed (rpm), line speed (m/min), constant rate of feeding time (min). * Speed monitor can display the speed set at E48. 																					
	Stopping	Displays the same contents as displayed during running.																					
	Alarm mode	Displays the cause of trip by codes as follows. <table border="0" style="width: 100%;"> <tr> <td><i>OC1</i> : Overcurrent during acceleration</td> <td><i>OC2</i> : Overcurrent during deceleration</td> </tr> <tr> <td><i>OC3</i> : Overcurrent at constant speed</td> <td><i>LIP</i> : Input phase loss</td> </tr> <tr> <td><i>LU</i> : Undervoltage</td> <td><i>OPL</i> : Output phase loss</td> </tr> <tr> <td><i>OU1</i> : Overvoltage during acceleration</td> <td><i>OU2</i> : Overvoltage during deceleration</td> </tr> <tr> <td><i>OU3</i> : Overvoltage during constant speed</td> <td><i>OH1</i> : Overheating of the heat sink</td> </tr> <tr> <td><i>OH2</i> : External thermal relay tripped</td> <td><i>OH4</i> : Motor protection (PTC thermistor)</td> </tr> <tr> <td><i>dbH</i> : Overheating of the DB circuit</td> <td><i>OL1</i> : Motor overload</td> </tr> <tr> <td><i>OLU</i> : Inverter unit overload</td> <td><i>Er1</i> : Memory error</td> </tr> <tr> <td><i>Er2</i> : Remote keypad communications error</td> <td><i>Er3</i> : CPU error</td> </tr> <tr> <td><i>Er5</i> : Operation procedure error</td> <td><i>ErB</i> : RS485 error</td> </tr> <tr> <td><i>ErF</i> : Data save error due to undervoltage</td> <td></td> </tr> </table> For details, refer to Section 8.6 "Protective Functions."	<i>OC1</i> : Overcurrent during acceleration	<i>OC2</i> : Overcurrent during deceleration	<i>OC3</i> : Overcurrent at constant speed	<i>LIP</i> : Input phase loss	<i>LU</i> : Undervoltage	<i>OPL</i> : Output phase loss	<i>OU1</i> : Overvoltage during acceleration	<i>OU2</i> : Overvoltage during deceleration	<i>OU3</i> : Overvoltage during constant speed	<i>OH1</i> : Overheating of the heat sink	<i>OH2</i> : External thermal relay tripped	<i>OH4</i> : Motor protection (PTC thermistor)	<i>dbH</i> : Overheating of the DB circuit	<i>OL1</i> : Motor overload	<i>OLU</i> : Inverter unit overload	<i>Er1</i> : Memory error	<i>Er2</i> : Remote keypad communications error	<i>Er3</i> : CPU error	<i>Er5</i> : Operation procedure error	<i>ErB</i> : RS485 error	<i>ErF</i> : Data save error due to undervoltage
<i>OC1</i> : Overcurrent during acceleration	<i>OC2</i> : Overcurrent during deceleration																						
<i>OC3</i> : Overcurrent at constant speed	<i>LIP</i> : Input phase loss																						
<i>LU</i> : Undervoltage	<i>OPL</i> : Output phase loss																						
<i>OU1</i> : Overvoltage during acceleration	<i>OU2</i> : Overvoltage during deceleration																						
<i>OU3</i> : Overvoltage during constant speed	<i>OH1</i> : Overheating of the heat sink																						
<i>OH2</i> : External thermal relay tripped	<i>OH4</i> : Motor protection (PTC thermistor)																						
<i>dbH</i> : Overheating of the DB circuit	<i>OL1</i> : Motor overload																						
<i>OLU</i> : Inverter unit overload	<i>Er1</i> : Memory error																						
<i>Er2</i> : Remote keypad communications error	<i>Er3</i> : CPU error																						
<i>Er5</i> : Operation procedure error	<i>ErB</i> : RS485 error																						
<i>ErF</i> : Data save error due to undervoltage																							
Running or alarm mode	Alarm history: Saves and displays the last 4 trip codes and their detailed description. (Even with the main power off, the alarm history data of the last 4 trips are retained.)																						
Protection	Refer to Section 8.6 "Protective Functions."																						
Environment	Refer to Chapter 1, Section 1.4 "Storage Environment" and Chapter 2, Section 2.1 "Operating Environment."																						

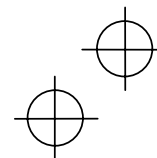
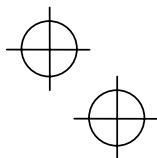

8.4 Terminal Specifications

8.4.1 Terminal Functions

For details about the main and control circuit terminals, refer to Chapter 2, Section 2.3.5 and Section 2.3.7 (Table 2.8), respectively.

8.4.2 Connection Diagram in Operation by External Signal Inputs

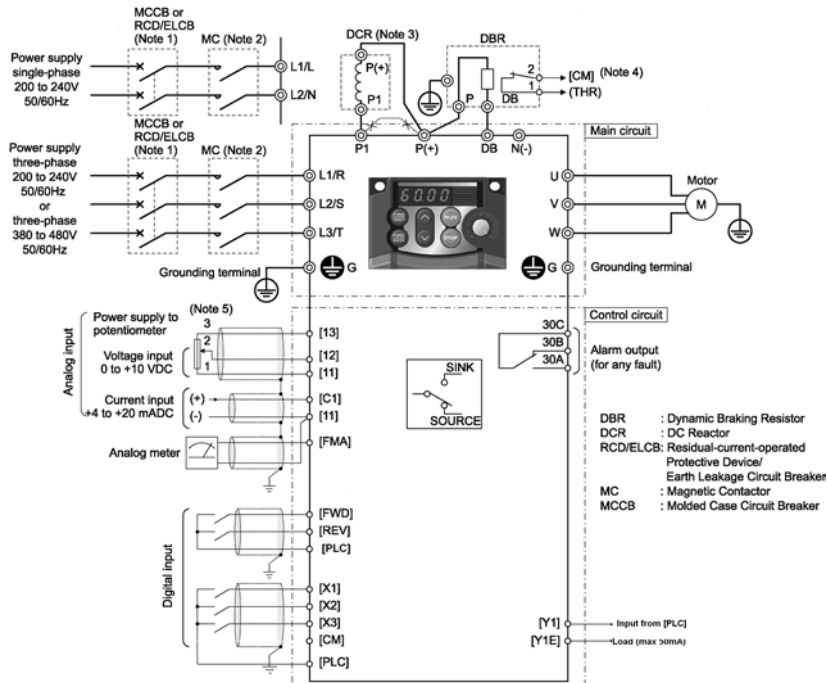

(Note 1) Install a recommended moulded case circuit breaker (MCCB) or a residual-current-operated protective device (RCD)/earth leakage circuit breaker (ELCB) (with the exception of those exclusively designed for protection from ground faults) in the primary circuit of the inverter to protect wiring. At this time, ensure that the circuit breaker capacity is equivalent to or lower than the recommended capacity.

(Note 2) A magnetic contactor (MC) should, if necessary, be mounted independent of the MCCB or ELCB to cut off the power fed to the inverter. Refer to page 9-2 for details. MCs or solenoids that will be installed close to the inverter require surge absorbers to be connected in parallel to their coils.

(Note 3) When connecting a DC reactor (optional accessory), remove the jumper bar from terminals [P1] and [P+]. For details on the terminal assignment, refer to page 10-1 of Chapter 10.

(Note 4) (THR) function can be used by assigning code "9" (Alarm from external equipment) to any of terminals [X1] to [X3], [FWD] or [REV] (function code E01 to E03, E98, or E99). For details, refer to Chapter 9.

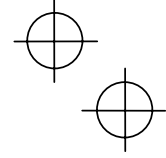
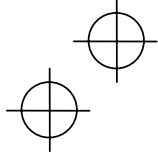

(Note 5) Frequency can be set by connecting a frequency command device (external potentiometer) between the terminals [11] and [13] instead of inputting voltage signal (0 to +10 VDC or 0 to +5 VDC) between the terminals [12] and [11].

(Note 6) For the wiring of the control circuit, use shielded or twisted wires. When using shielded wires, connect the shields to . To prevent malfunction due to noise, keep the control circuit wiring away from the main circuit wiring as far as possible (recommended: 10 cm or longer), and never set them in the same wire duct. When crossing the control circuit wiring with the main circuit wiring, set them at right angles.

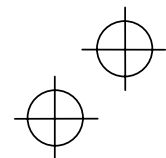
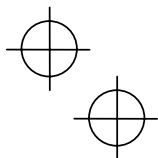

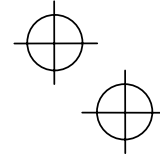
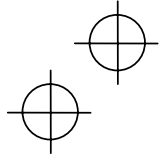

8.5 External Dimensions

8.5.1 Standard Models

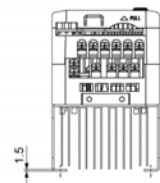
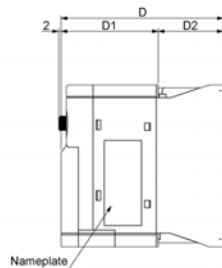
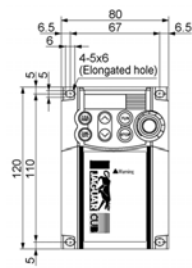

Power supply voltage	Inverter type	Dimensions (mm)		
		D	D1	D2
Three-phase 200 V	CUB3A-2	95	70	25
	CUB5A-2	120		50
Single-phase 200 V	CUB3A-1	95	70	25
	CUB5A-1	140	90	50

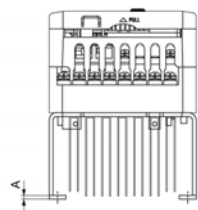
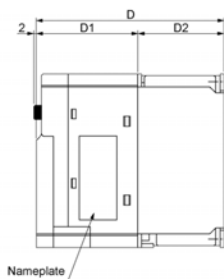
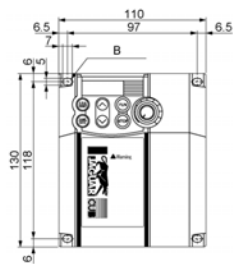

Power supply voltage	Inverter type	Dimensions (mm)				
		D	D1	D2	A	B
Three-phase 400 V	CUB1A5-4	115	75	40	3	4-5x7 (Elongated hole)
	CUB2A5-4	139		64		

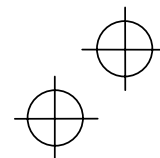
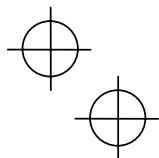

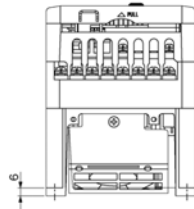
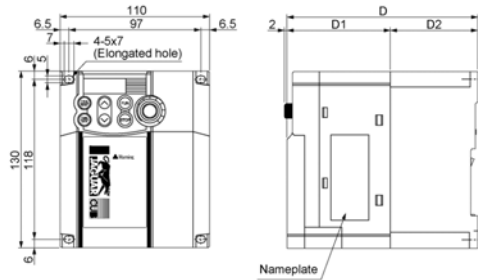
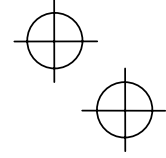
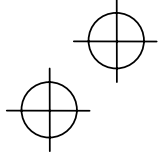

Power supply voltage	Inverter type	Dimensions (mm)		
		D	D1	D2
Three-phase 200 V	CUB8A-2	139	75	64
	CUB11A-2			
Three-phase 400 V	CUB3A7-4	149	85	
	CUB5A5-4			
Single-phase 200 V	CUB8A-1			

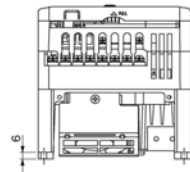
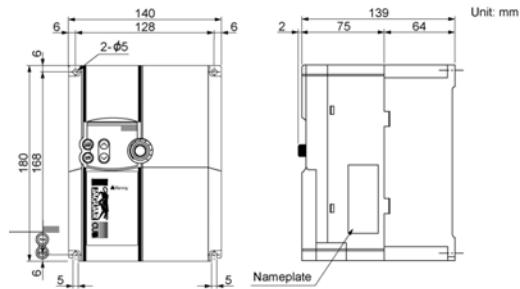

Power supply voltage	Inverter type
Three-phase 200 V	CUB17A-2
Three-phase 400 V	CUB9A-4
Single-phase 200 V	CUB11A-1

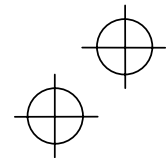
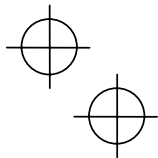

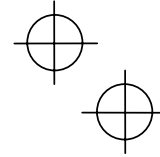
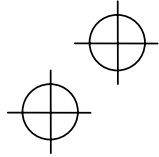

8.5.2 Models Available on Order (EMC Filter Built-in Type)

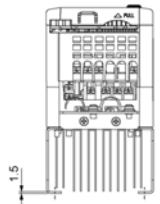
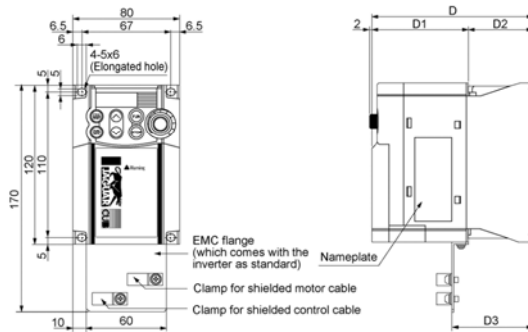

Power supply voltage	Inverter type	Dimensions (mm)			
		D	D1	D2	D3
Three-phase 200 V	CUB3A-2E	115	25	36.2	
	CUB5A-2E	140	50	61.2	
Single-phase 200 V	CUB3A-1E	115	90	25	36.2

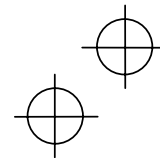
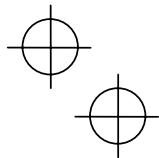

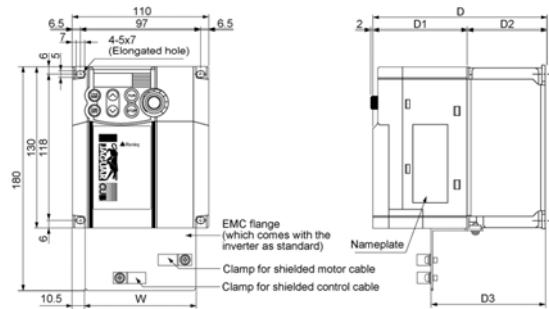
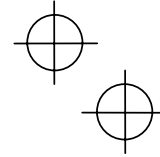
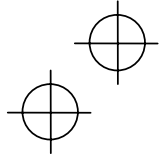

Power supply voltage	Inverter type	Dimensions (mm)				
		W	D	D1	D2	D3
Three-phase 400 V	CUB1A5-4E	89	158	118	40	61.5
	CUB2A5-4E	89	182	118	64	85.5
Single-phase 200 V	CUB5A-1E	60	139	99	40	55.2

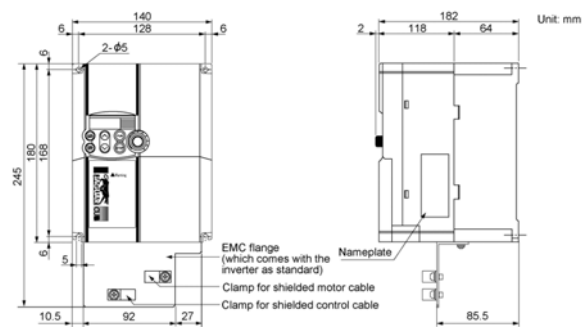
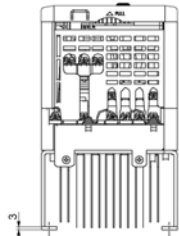

Power supply voltage	Inverter type
Three-phase 200 V	CUB8A-2E
	CUB11A-2E
	CUB17A-2E
Three-phase 400 V	CUB3A7-4E
	CUB5A5-4E
	CUB9A-4E
Single-phase 200 V	CUB8A-1E
	CUB11A-1E

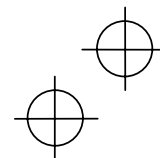
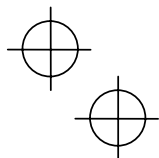
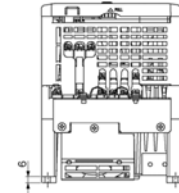



8.6 Protective Functions

Name	Description	LED monitor displays	Alarm output [30A,B,C]	
Overcurrent protection	<ul style="list-style-type: none"> - Stops the inverter output to protect the inverter from an overcurrent resulting from overload. - Stops the inverter output to protect the inverter from an overcurrent due to a short circuit in the output circuit. - Stops the inverter output to protect the inverter from an overcurrent due to a ground fault in the output circuit. This protection is effective only when the inverter starts. If you turn on the inverter without removing the ground fault, this protection may not work. 	During acceleration	Yes	
		During deceleration		<i>OC2</i>
		During running at constant speed		<i>OC3</i>
Overvoltage protection	<p>The inverter stops the inverter output by detecting an overvoltage (400 VDC for 200V series, 800 VDC for 400V series) in the DC link circuit. This protection is not assured if excess AC line voltage is applied inadvertently.</p>	During acceleration	Yes	
		During deceleration		<i>OU2</i>
		During running at constant speed (Stopped)		<i>OU3</i>
Undervoltage protection	<p>Stops the inverter output when the DC link circuit voltage drops below the undervoltage level (200 VDC for 200 V series, 400 VDC for 400 V series). However, if data "4 or 5" is selected for F14, no alarm is output even if the DC link circuit voltage drops.</p>	<i>LU</i>	Yes ¹⁾	
Input phase loss protection	<p>Detects input phase loss, stopping the inverter output. This function prevents the inverter from undergoing heavy stress that may be caused by input phase loss or interphase voltage unbalance exceeding 6% and may damage the inverter. If connected load is light or a DC reactor is connected to the inverter, this function will not detect input phase loss if any. In single-phase series of inverters, this function is disabled by factory default.</p>	<i>Lin</i>	Yes	
Output phase loss protection	Detects breaks in inverter output wiring at the start of running and during running, stopping the inverter output.	<i>OPL</i>	Yes	
Overheat protection	Inverter	- Stops the inverter output by detecting excess heat sink temperature in case of cooling fan failure or overload.	<i>OH1</i>	Yes
	Braking resistor	<ul style="list-style-type: none"> - When the built-in or external braking resistor overheats, the inverter stops running. * It is necessary to set the function code data corresponding to the resistor used (built-in or external). 	<i>dbH</i>	Yes
Overload protection	Stops the inverter output if the Insulated Gate Bipolar Transistor (IGBT) internal temperature calculated from the output current and cooling fan temperature detection is over the preset value.	<i>OLU</i>	Yes	
Motor protection	Electronic thermal overload relay	<p>In the following cases, the inverter stops running the motor to protect the motor in accordance with the electronic thermal function setting.</p> <ul style="list-style-type: none"> - Protects general-purpose motors over the entire frequency range. - Protects inverter motors over the entire frequency range. * The operation level and thermal time constant can be set. 	<i>OL1</i>	Yes

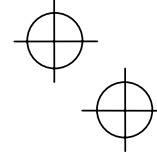
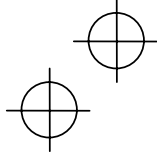
¹⁾This alarm may not be outputted depending upon the data setting of the function code.



Name	Description	LED monitor displays	Alarm output [30A,B,C]
Motor protection	PTC thermistor	- A PTC thermistor input stops the inverter output for motor protection. A PTC thermistor is connected between terminals [C1] and [11], and a 1-kΩ external resistor is connected between terminals [13] and [C1].	OH4 Yes
	Overload early warning	Outputs a preliminary alarm at a preset level before the motor is stopped by the electronic thermal function for the purpose of protecting the motor.	— —
Stall prevention	Operates when instantaneous overcurrent limiting is active. - Instantaneous overcurrent limiting: Operates if the inverter's output current exceeds the instantaneous overcurrent limit level, avoiding tripping of the inverter (during constant speed operation or during acceleration).	— —	— —
External alarm input	- Stops the inverter output with an alarm through the digital input signal (THR).	OH2	Yes
Alarm relay output (for any fault)	- The inverter outputs a relay contact signal when the inverter issues an alarm and stops the inverter output. < Alarm Reset > The alarm stop state is reset by pressing the  key or by the digital input signal (RST). < Saving the alarm history and detailed data > The information on the previous 4 alarms can be saved and displayed.	—	Yes
Memory error	The inverter checks memory data after power-on and when the data is written. If a memory error is detected, the inverter stops.	Er1	Yes
Remote keypad communications error	The inverter stops by detecting a communication error between the inverter and the remote keypad (option) during operation from the remote keypad.	Er2	Yes
CPU error	If the inverter detects a CPU error caused by noise or some other factor, the inverter stops.	Er3	Yes
Operation Protection	STOP key priority Pressing  key on the keypad forces the inverter to decelerate and stop the motor even if the inverter is running by any run commands given via the terminals or communications (link operation). After the motor stops, the inverter issues alarm "Er6."	Er6	Yes

"—": Not applicable.

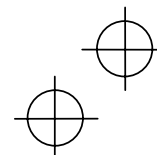
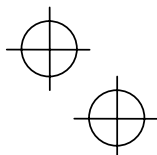

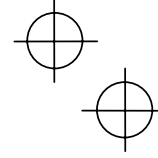
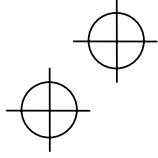

Name	Description		LED monitor displays	Alarm output [30A,B,C]
Operation Protection	Start check function	Inverters prohibit any run operations and displays "Er6" on the LED of keypad if any run command is given when: - Powering up - Releasing an alarm (ⓘ key turned on) - Link command (LE) has switched inverter operations	Er6	Yes
RS485 communication error	On detecting an RS485 communication error, the inverter displays the alarm code.		Er8	Yes
Data save error during undervoltage	If the data could not be saved during activation of the undervoltage protection function, the inverter displays the alarm code.		ErF	Yes

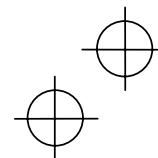
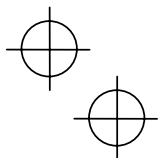

Chapter 9 LIST OF PERIPHERAL EQUIPMENT AND OPTIONS

The table below lists the main peripheral equipment and options that are connected to the Jaguar CUB. Use them in accordance with your system requirements.

	Name of peripheral equipment	Function and application																																																												
Main peripheral equipment	<p>Moulded case circuit breaker (MCCB)</p> <p>Residual-current-operated protective device (RCD)</p> <p>/Earth leakage circuit breaker (ELCB)*</p> <p>* With the exception of those exclusively designed for protection from ground faults</p>	<p>MCCBs are designed to protect the power circuits between the power control board and inverter's main terminals (L1/R, L2/S and L3/T for three-phase power, L1/L and L2/N for single-phase power) from overload or short-circuit which in turn prevents secondary disasters caused by the inverter malfunctioning.</p> <p>RCDs/ELCBs function in the same way as MCCBs. Use the MCCBs and RCDs/ELCBs that satisfy the recommended rated current listed below.</p> <table border="1" data-bbox="643 869 1059 1227"> <thead> <tr> <th rowspan="2">Power supply voltage</th> <th rowspan="2">Applicable motor rating (kW)</th> <th rowspan="2">Inverter type</th> <th colspan="2">Recommended rated current (A) of MCCB and RCD/ELCB</th> </tr> <tr> <th>w/ DC reactor</th> <th>w/o DC reactor</th> </tr> </thead> <tbody> <tr> <td rowspan="5">Three-phase 200 V</td> <td>0.4</td> <td>CUB3A-2□</td> <td rowspan="2">5</td> <td>5</td> </tr> <tr> <td>0.75</td> <td>CUB5A-2□</td> <td>10</td> </tr> <tr> <td>1.5</td> <td>CUB8A-2□</td> <td rowspan="3">10</td> <td>15</td> </tr> <tr> <td>2.2</td> <td>CUB11A-2□</td> <td>20</td> </tr> <tr> <td>4.0</td> <td>CUB17A-2□</td> <td>30</td> </tr> <tr> <td rowspan="5">Three-phase 400 V</td> <td>0.4</td> <td>CUB1A5-4□</td> <td rowspan="2">5</td> <td>5</td> </tr> <tr> <td>0.75</td> <td>CUB2A5-4□</td> <td>10</td> </tr> <tr> <td>1.5</td> <td>CUB3A7-4□</td> <td rowspan="3">10</td> <td>15</td> </tr> <tr> <td>2.2</td> <td>CUB5A5-4□</td> <td>20</td> </tr> <tr> <td>4.0</td> <td>CUB9A-4□</td> <td>30</td> </tr> <tr> <td rowspan="4">Single-phase 200 V</td> <td>0.4</td> <td>CUB3A-1□</td> <td>5</td> <td>5</td> </tr> <tr> <td>0.75</td> <td>CUB5A-1□</td> <td>10</td> <td>10</td> </tr> <tr> <td>1.5</td> <td>CUB8A-1□</td> <td>15</td> <td>20</td> </tr> <tr> <td>2.2</td> <td>CUB11A-1□</td> <td>20</td> <td>30</td> </tr> </tbody> </table> <p>Note 1) A box (□) in the above table replaces E suffix for filtered version</p> <p>The rated current and circuit breaking capacity depend on the power supply voltage.</p>	Power supply voltage	Applicable motor rating (kW)	Inverter type	Recommended rated current (A) of MCCB and RCD/ELCB		w/ DC reactor	w/o DC reactor	Three-phase 200 V	0.4	CUB3A-2□	5	5	0.75	CUB5A-2□	10	1.5	CUB8A-2□	10	15	2.2	CUB11A-2□	20	4.0	CUB17A-2□	30	Three-phase 400 V	0.4	CUB1A5-4□	5	5	0.75	CUB2A5-4□	10	1.5	CUB3A7-4□	10	15	2.2	CUB5A5-4□	20	4.0	CUB9A-4□	30	Single-phase 200 V	0.4	CUB3A-1□	5	5	0.75	CUB5A-1□	10	10	1.5	CUB8A-1□	15	20	2.2	CUB11A-1□	20	30
Power supply voltage	Applicable motor rating (kW)	Inverter type				Recommended rated current (A) of MCCB and RCD/ELCB																																																								
			w/ DC reactor	w/o DC reactor																																																										
Three-phase 200 V	0.4	CUB3A-2□	5	5																																																										
	0.75	CUB5A-2□		10																																																										
	1.5	CUB8A-2□	10	15																																																										
	2.2	CUB11A-2□		20																																																										
	4.0	CUB17A-2□		30																																																										
Three-phase 400 V	0.4	CUB1A5-4□	5	5																																																										
	0.75	CUB2A5-4□		10																																																										
	1.5	CUB3A7-4□	10	15																																																										
	2.2	CUB5A5-4□		20																																																										
	4.0	CUB9A-4□		30																																																										
Single-phase 200 V	0.4	CUB3A-1□	5	5																																																										
	0.75	CUB5A-1□	10	10																																																										
	1.5	CUB8A-1□	15	20																																																										
	2.2	CUB11A-1□	20	30																																																										

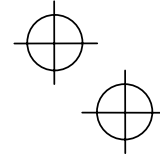
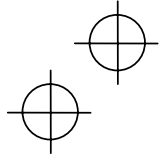

	Name of peripheral equipment	Function and application
Main peripheral equipment	Moulded case circuit breaker Earth leakage circuit breaker* * With the exception of those exclusively designed for protection from ground faults	<div style="border: 1px solid black; padding: 5px;"> <p style="text-align: center;">⚠ WARNING</p> <p>When connecting the inverter to the power supply, add a recommended molded case circuit breaker and earth leakage circuit breaker* in the path of power supply. Do not use the devices with the rated current out of the recommended range.</p> <p>*With the exception of those exclusively designed for protection from ground faults</p> <p>Fire could occur.</p> </div>
	Magnetic contactor (MC)	<p>An MC can be used at both the power input and output sides of the inverter. At each side, the MC works as described below. When inserted in the output circuit of the inverter, an MC can also switch the motor drive power source between the inverter output and commercial power lines.</p> <p>■ At the power source side</p> <p>Insert an MC in the power source side of the inverter in order to:</p> <ol style="list-style-type: none"> 1) Forcibly cut off the inverter from the power source (generally, commercial/factory power lines) with the protection function built into the inverter, or with the terminal signal line. 2) Stop the inverter operation in an emergency when the inverter cannot interpret the stop command due to internal/external circuit failures. 3) Cut off the inverter from the power source when the MCCB inserted in the power source side cannot cut it off for maintenance or inspection purpose. For the purpose only, it is recommended that you use an MC capable of turning the MC on/off manually. <p>Note: When your system requires the motor(s) driven by the inverter to be started/stopped with the MC, the frequency of the starting/stopping operation should be once or less per hour. The more frequent the operation, the shorter operation life of the MC and capacitor/s used in the DC link circuit due to thermal fatigue caused by the frequent charging of the DC Link. If this is not necessary, start/stop the motor with the terminal commands (FWD), (REV) and/or (HLD), or with the keypad.</p> <p>■ At the output side</p> <p>Prevent externally turned-around current from being applied to the inverter power output terminals (U, V, and W) unexpectedly. An MC should be used, for example, if a circuit that switches the motor driving source between the inverter output and commercial/factory power lines is connected to the inverter.</p> <p>Note: As application of high voltage external current to the inverter's secondary (output) circuits may break the IGBTs, MCs should be used in the power control system circuits to switch the motor drive power source to the commercial/factory power lines after the motor has come to a complete stop. Also ensure that voltage is never mistakenly applied to the inverter output terminals due to unexpected timer operation, or similar.</p> <p>■ Driving the motor using commercial power lines</p> <p>MCs can also be used to switch the power source of the motor driven by the inverter to a commercial power source.</p>

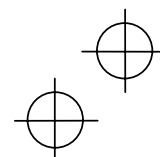
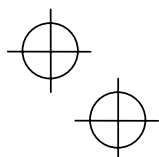

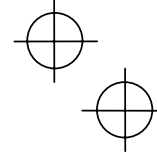
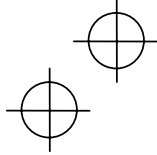

	Name of option	Function and application
Main option	Braking resistors (Standard model) (DBRs)	A braking resistor converts regenerative energy generated from deceleration of the motor and converts it to heat for consumption. Use of a braking resistor results in improved deceleration performance of the inverter.
	DC reactors (DCRs)	<p>A DCR is mainly used for power supply normalization and for supplied power-factor correction (for reducing harmonic components).</p> <p>1) For power supply normalization</p> <ul style="list-style-type: none"> - Use a DCR when the capacity of a power supply transformer exceeds 500 kVA and is 10 times or more the rated inverter capacity. In this case, the percentage-reactance of the power source decreases, and harmonic components and their peak levels increase. These factors may break rectifiers or capacitors in the converter section of inverter, or decrease the capacitance of the capacitor (which can shorten the inverter's service life). - Also use a DCR when there are thyristor-driven loads or when condensive capacitors are being turned on/off. - Use a DCR when the interphase voltage unbalance ratio of the inverter power source exceeds 2%. $\text{Interphase voltage unbalance (\%)} = \frac{\text{Max. voltage (V)} - \text{Min. voltage (V)}}{3\text{-phase average voltage (V)}} \times 67$ <p>2) For supplied power-factor correction (harmonic component reduction)</p> <p>Generally a capacitor is used to correct the power factor of the load, however, it cannot be used in a system that includes an inverter. Using a DCR increases the reactance of inverter's power source so as to decrease harmonic components on the power source lines and correct the power factor of inverter. Using a DCR corrects the input power factor to approximately 90 to 95%.</p> <p>Note: At the time of shipping, a jumper bar is connected across the terminals P1 and P (+) on the terminal block. Remove the jumper bar when connecting a DCR.</p>
	Output circuit filters (OFLs)	<p>Include an OFL in the inverter power output circuit to:</p> <ol style="list-style-type: none"> 1) Suppress the voltage fluctuation at the motor input terminals This protects the motor from insulation damage caused by the application of high voltage surge currents by the 400 V class of inverters. 2) Suppress leakage current from the power output lines (due to harmonic components) This reduces the leakage current when the motor is connected by long cable lengths. It is recommended that the length of the motor cable be kept to less than 400 m. 3) Minimize emission and/or induction noise generated from the motor cable. OFLs are effective in reducing noise from long power feed lines, such as those used in plants, etc. <p>Note: Use an OFL within the allowable carrier frequency range specified by function code F26. Otherwise, the filter will overheat.</p>

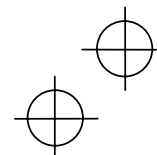
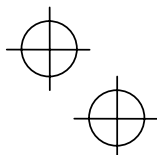

	Name of option	Function and application
Main option	Ferrite ring reactors for reducing radio frequency noise (ACL)	An ACL is used to reduce radio noise emitted by the inverter. An ACL suppresses the outflow of high frequency harmonics caused by switching operation for the power supply lines inside the inverter. Pass the power supply lines together through the ACL. If wiring length between the inverter and motor is less than 20 m, insert an ACL to the power supply lines; if it is more than 20 m, insert it to the motor output cables of the inverter.
Options for Operation and Communications	External potentiometer for frequency commands	An external potentiometer may be used to set the drive frequency. Connect the potentiometer to control signal terminals 11 to 13 of the inverter.
	Remote keypad	This allows you to perform remote operation of the inverter. With the remote keypad, you may copy function code data set in the inverter to any other inverter.
	Extension cable for remote operation	The extension cable connects the inverter with the remote keypad to enable remote operation of the inverter. 5 m, 3 m and 1 m cables are available.
	RS485 communications card	This makes communication to a PLC or personal computer system possible.
	Inverter support loader software	Inverter support loader software, Windows based, that makes setting of function codes easy. The RS485 communications card must be connected.
Other peripheral equipment	Surge absorbers	A surge absorber suppresses surge currents and noise from the power lines to ensure effective protection of your power system from the malfunctioning of magnetic contactors, mini-relays and timers etc.
	Surge killers	A surge suppressor eliminates surge currents induced by lightening and noise from the power supply lines. Use of a surge suppressor is effective in preventing the electronic equipment, including inverters, from damage or malfunctioning caused by such surges and/or noise.
	Arresters	An arrester suppresses surge currents and noise invaded from the power supply lines. Use of an arrester is effective in preventing electronic equipment, including inverters, from damage or malfunctioning caused by such surges and/or noise.
	Frequency meter	Displays the frequency in accordance with signal output from the inverter.
Other options	Rail mounting bases	A rail mounting base allows any of the Jaguar CUB series of inverters to be mounted on a DIN rail (35 mm wide).

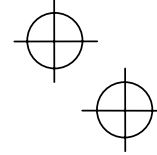
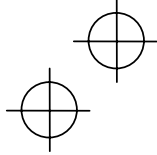

Chapter 10 COMPLIANCE WITH STANDARDS

10.1 Compliance with UL Standards and Canadian Standards (cUL certification)

10.1.1 General

Originally, the UL standards were established by Underwriters Laboratories, Inc. as private criteria for inspections/investigations pertaining to fire/accident insurance in the USA. Later, these standards were authorized as the official standards to protect operators, service personnel and the general populace from fires and other accidents in the USA.

cUL certification means that UL has given certification for products to clear CSA Standards. cUL certified products are equivalent to those compliant with CSA Standards.

10.1.2 Considerations when using Jaguar CUB in systems to be certified by UL and cUL

If you want to use the Jaguar CUB series of inverters as a part of a UL Standards or CSA Standards (cUL certified) certified product, refer to the related guidelines described on page viii.

10.2 Compliance with European Standards

The CE marking on IMO products indicates that they comply with the essential requirements of the Electromagnetic Compatibility (EMC) Directive 89/336/EEC issued by the Council of the European Communities and Low Voltage Directive 73/23/EEC.

Only the EMC filter built-in type of inverters that bear a CE marking are compliant with these EMC Directives.

Inverters that bear a CE marking or TÜV mark are compliant with the Low Voltage Directive.

The products comply with the following standards:

Low Voltage Directive	EN50178:	1997
EMC Directives	EN61800-3:	1996+A11 : 2000
	EN55011:	1998+A : 1999
	Immunity:	Second environment (EN61800-3+A11 Industrial)
	Emission:	Class 1A (EN55011+A1)
	(Applicable only to the EMC filter built-in type of inverters)	

CAUTION

The Jaguar CUB series of inverters are categorized as a "restricted sales distribution class" of the EN61800-3. When you use these products with any home appliances or office equipment, you may need to take appropriate countermeasures to reduce or eliminate any noise emitted from these products.

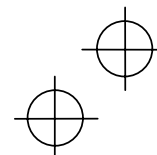
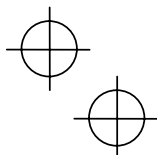

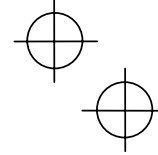
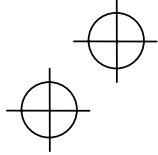

10.3 Compliance with EMC Standards

10.3.1 General

The CE marking on the EMC filter built-in type of inverters does not ensure that the entire equipment including our CE-marked products is compliant with the EMC Directive. Therefore, CE marking for the equipment shall be the responsibility of the equipment manufacturer. For this reason, IMO's CE mark is indicated under the condition that the product shall be used within equipment meeting all requirements for the relevant Directives. Instrumentation of such equipment shall be the responsibility of the equipment manufacturer.

Generally, machinery or equipment includes not only our products but other devices as well. Manufacturers, therefore, shall design the whole system to be compliant with the relevant Directives.

In addition, to satisfy the requirements noted above, use the EMC filter built-in type of inverters according to the descriptions contained in this instruction manual. Installing the inverter(s) in a metal enclosure may be necessary, depending upon the operating environment of the equipment that the inverter is to be used with.

10.3.2 Recommended installation

To make the machinery or equipment fully compliant with the EMC Directive, have certified technicians wire the motor and inverter in strict accordance with the procedure described below.

Use the EMC filter built-in type of inverters.

- (1) Mount the EMC grounding flange (that comes with the inverter) to the inverter with screws in order to ground the wire shield(s). (See Figure 10.1.)

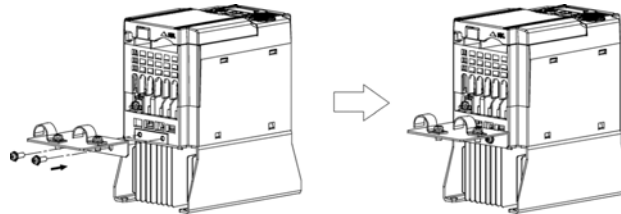
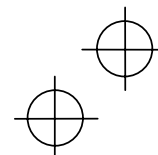
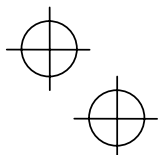
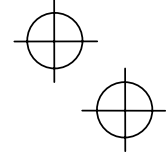
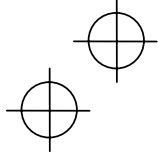

Figure 10.1 Attaching the EMC Grounding Flange

- (2) Use shielded wires for the motor cable and route it as short as possible. Firmly clamp the wire shield to the flange to ground it. Further, connect the wire shield electrically to the grounding terminal of motor. (See Figure 10.2.)





- (3) Use shielded wires for the control signals of the inverter to input to/output from the control terminals. Firmly clamp the control wire shields to the EMC grounding flange (in the same way as the motor cables).

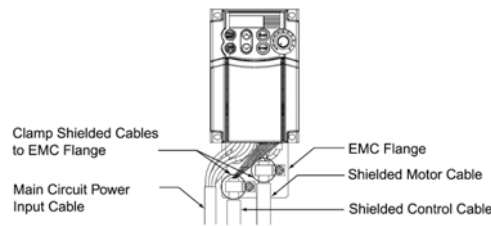

Figure 10.2 Connecting Shielded Cables

- (4) If noise from the inverter exceeds the permissible level, enclose the inverter and its peripherals within a metal enclosure as shown in Figure 10.3.

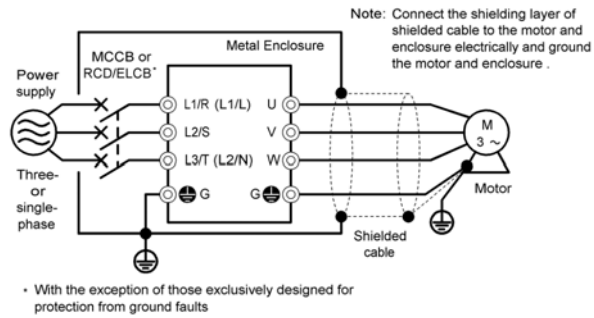
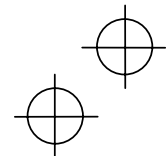
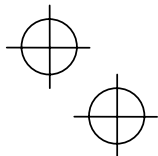
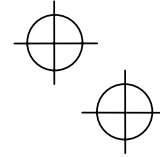
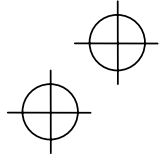

Figure 10.3 Installing the Inverter into a Metal Enclosure





10.4 Harmonic Component Regulation in the EU

10.4.1 General comments

When you use general-purpose industrial inverters in the EU, the harmonics emitted from the inverter to power lines are strictly regulated as stated below.

If an inverter whose rated input is 1 kW or less is connected to low-voltage commercial power lines, it is regulated by the harmonics emission regulations from inverters to power lines (with the exception of industrial low-voltage power lines). Refer to Figure 10.4 below for details.

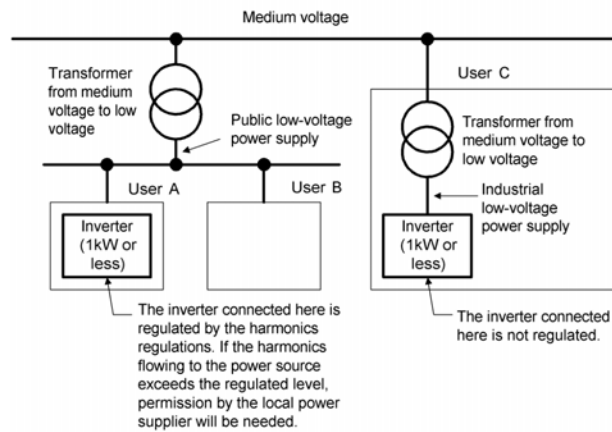
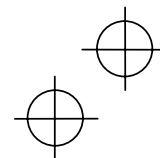
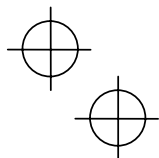
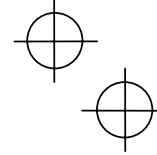
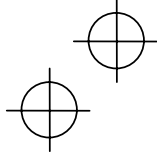

Figure 10.4 Power Source and Regulation





10.4.2 Compliance with the harmonic component regulation

Table 10.1 Compliance with Harmonic Component Regulation

Power supply voltage	Inverter type	w/o DC reactor	w/ DC reactor
Three-phase 200 V	CUB3A-2□	√*	√*
	CUB5A-2□	√*	√*
Three-phase 400 V	CUB1A5-4□	—	√
	CUB2A5-4□	—	√
Single-phase 200 V	CUB3A-1□	—	√
	CUB5A-1□	—	—

*Inverter types marked with √ in the table above are compliant with the EN61000-3-2 (+A14), so they may be connected to public low-voltage power supply unconditionally. Conditions apply when connecting models marked with "—". If you want to connect them to public low-voltage power supply, you need to obtain permission from the local electric power supplier. In general, you will need to provide the supplier with the harmonics current data of the inverter. To obtain the data, contact IMO.

Note 1) Boxes (□) in the table above replace E suffix for Filtered version

2) When supplying three-phase 200 VAC power stepped down from a three-phase 400 VAC power line using a transformer, the level of harmonic flow from the 400 VAC line will be regulated.

10.5 Compliance with the Low Voltage Directive in the EU

10.5.1 General

General-purpose inverters are regulated by the Low Voltage Directive in the EU. The Manufacturer has obtained the proper certification for the Low Voltage Directive from the official inspection agency. IMO states that all our inverters with CE and/or TÜV marking are compliant with the Low Voltage Directive.

10.5.2 Points for Consideration when using the Jaguar CUB series in a system to be certified by the Low Voltage Directive in the EU

If you want to use the Jaguar CUB series of inverters in systems/equipment/appliances in the EU, refer to the guidelines on page vi.

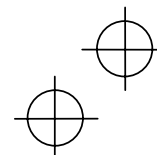
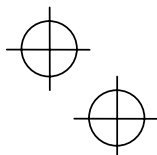

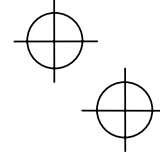
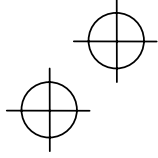

Compact Inverter

Jaguar CUB

Instruction manual

First Edition, December 2003

Second Edition, January 2004

IMO Precision Controls Ltd

The purpose of this manual is to provide accurate information in the handling, setting up and operating of the Jaguar CUB series of inverters. Please feel free to send your comments regarding any errors or omissions you may have found, or any suggestions you may have for generally improving the manual.

In no event will IMO Precision Controls Ltd. be liable for any direct or indirect damages resulting from the application of the information in this manual.

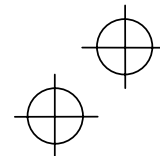
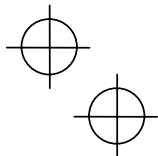

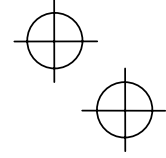
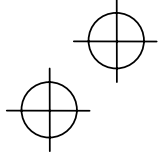

IMO Precision Controls Ltd

Automation and Controls

1000 North Circular Road, Staples Corner, London, NW2 7JP, United Kingdom

Phone: +44(0)20 8452 6444 Fax: +44(0)20 8450 2274

URL <http://www.imopc.com>

