

# Isolators 69 Series

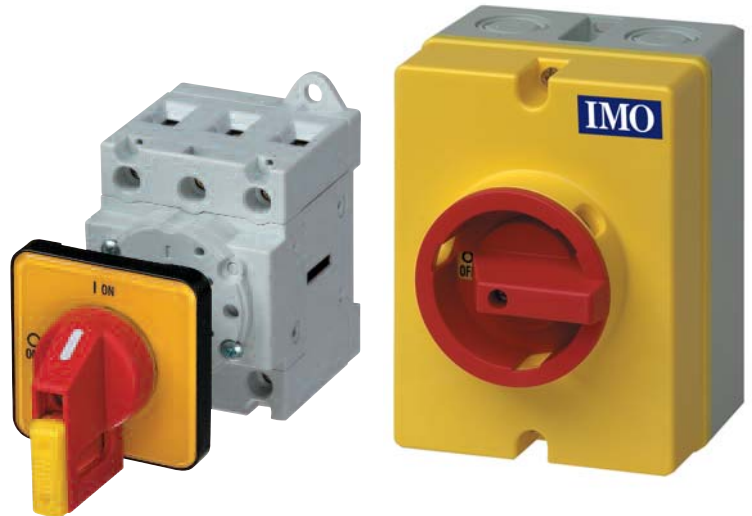

- 3 and 4 pole
- On load 20A - 100A
- Red/yellow or black handles
- 3 padlock positions
- IP65
- Enclosed, DIN rail, base or panel mount versions
- Lightweight ext shafts 100-400mm
- Side mounted auxiliary contacts
- UL approval



## Options and ordering codes

<b>PM69</b>		-	<b>30</b>	<b>20</b>	<b>RY64</b>	
IP65 enclosed	<b>PE69</b>		3 pole	<b>30</b>	<b>RY48</b>	Direct red/yellow 48mm handle
Base mount door interlock	<b>LB69</b>		4 pole	<b>40</b>	<b>RY64</b>	Direct red/yellow 64mm handle
Front panel mount	<b>PM69</b>		6 pole	<b>60</b>	<b>B48</b>	Direct black 48mm handle
Direct handle base mounted	<b>DM69</b>		8 pole	<b>80</b>	<b>B64</b>	Direct black 64mm handle
						Enclosed/door interlocked vertical
				<b>Rating @ 400V</b> AC21/Amps      AC23/kW		
				<b>20</b>	<b>5.5</b>	
				<b>25</b>	<b>7.5</b>	
				<b>32</b>	<b>11</b>	
				<b>40</b>	<b>15</b>	
				<b>63</b>	<b>18.5</b>	
				<b>80</b>	<b>22</b>	
				<b>100</b>	<b>37</b>	

## Accessories

Description	Part ref
Red/yellow handle 64 x 64mm	H69-0001
Black handle 64 x 64mm	H69-0002
Red/yellow handle 48 x 48mm	H69-0003
Black handle 48 x 48mm	H69-0004
Door handle mounting tool	J7049
Extension shaft – 100mm	E69-0001
Extension shaft – 200mm	E69-0002
Extension shaft – 300mm	E69-0003
Extension shaft – 400mm	E69-0004
Auxiliary contacts 1 n/o + 1 n/c	A69-0001
Auxiliary contacts 2 n/o	A69-0002
Solid neutral block	SN69-0001
Add on neutral switching pole 20-40A	SP69-0001
Auxiliary contacts 1 n/o + 1 n/c	A69-0001
Auxiliary contacts 2 n/o only	A69-0002

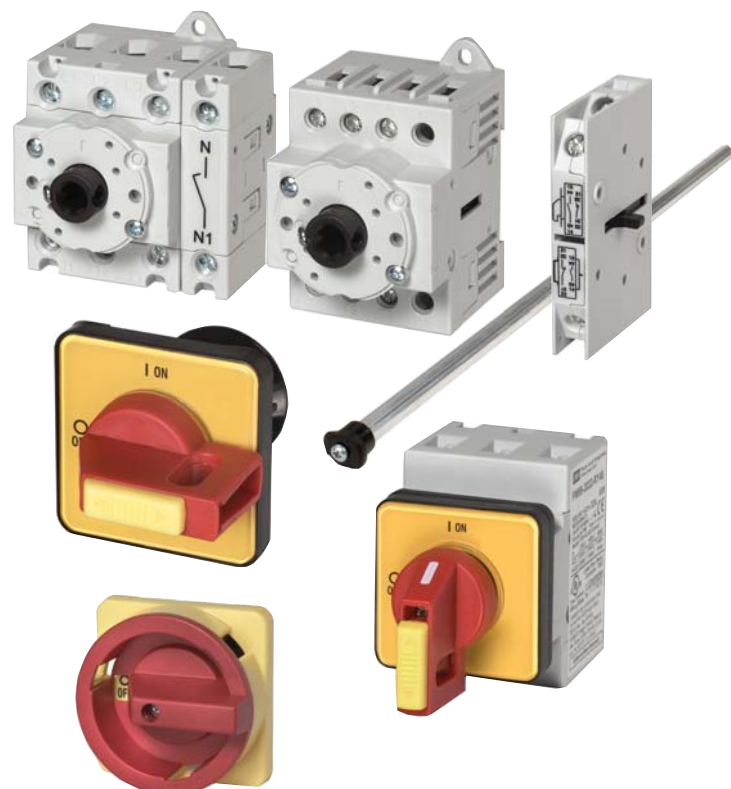

## Technical Data

Data according to IEC 947-3, IEC 947-5-1, VDE 0660, EN 60947-3, EN 60947-5-1

Type	..69..20	..69..25	..69..32	..69..40	..69..63	..69..80	..69..100	
<b>Main contacts</b>								
Rated thermal current $I_{th}$ open	A	20	25	32	40	63	80	100
Rated thermal current $I_{th}$ enclosed	A	20	25	32	40	63	80	100
Rated insulation voltage $U_i$ <sup>1)</sup>	V	690	690	690	690	690	690	1000 <sup>5)</sup>
Rated operational current $I_e$ AC21A	A	20	25	32	40	63	80	100
Making capacity $I_{eff}$ 3x220-440V	A	160	190	220	300	370	440	725
Breaking capacity 3x380-440V 3x660-690V	A	160	180	200	250	330	380	580
	A	160	180	200	250	330	380	580
	A	80	110	140	170	190	220	330
Disconnection property performed up to	V	690	690	690	690	690	690	1000
Motor Switch AC3 3x400V	A	12	16	23	30	37	37	60
Motor Switch AC3 3x220-240V	kW	3	4	5,5	7,5	11	11	18,5
Direct switching of single motors 3x380-440V 3x660-690V	kW	5,5	7,5	11	15	18,5	18,5	30
	kW	5,5	7,5	11	15	18,5	18,5	22
	kW	5,5	7,5	11	15	18,5	18,5	22
Main Switch AC23 3x400V	A	16	20	25	32	45	45	72
Motor Switch, AC23A 3x220-240V	kW	4	5,5	7,5	9	15	15	22
Main Switch, AC23B 3x380-440V	kW	7,5	10	12,5	16	22	22	37
Safety Switch 3x660-690V	kW	5,5	7,5	11	15	18,5	18,5	30
Rated conditional short-circuit current	kA <sub>eff</sub>	10	10	10	10	10	10	10
Max. fuse size gL (gG)	A	25	35	40	50	63	80	100
Mechanical life	x10 <sup>3</sup>	200	200	200	200	100	100	100
Rated short-time withstand current (1 sec. current)	A	250	300	400	500	600	850	1200
<b>Maximum ambient temperature</b>								
Operation	Open							-40°C to +60°C
	enclosed							-40°C to +40°C
	storage							-50°C to +90°C
<b>Cable cross sections</b>								
solid or standard	mm <sup>2</sup>	0,5 - 10			1 - 25		4 - 50	
	AWG	20 - 8 (10)			16 - 4 (10)		10 - 0 (10)	
flexible (+ multicore cable end)	mm <sup>2</sup>	0,5 - 6			4 - 16		10 - 35	
	AWG	20 - 10			16 - 6		8 - 2	
	mm <sup>2</sup>	0,5 - 6			0,75 - 16		6 - 35	
Size of terminal screw	AWG	20 - 10			16 - 6		8 - 2	
		M3,5			M5		M6	
	Nm	0,8 - 1,7			2 - 4		3,5 - 4,5	
<b>Auxiliary contacts</b>								
Rated insulation voltage $U_i$ <sup>1)</sup>	V	690				690	690	
Rated thermal current $I_{th}$ , $I_{the}$	A	10				10	10	
Switching capacity AC15 220-240V	A	2,5				2,5	2,5	
	A	1,5				1,5	1,5	
Rated conditional short-circuit current	kA <sub>eff</sub>	3				3	3	
	A	10				10	10	
<b>Cable cross sections</b>								
Solid or standard	mm <sup>2</sup>	0,75 - 2,5			0,75 - 2,5		0,75 - 2,5	
	AWG	14 - 12			14 - 12		14 - 12	
flexible (+ multicore cable end)	mm <sup>2</sup>	0,75 - 2,5 (1,5)			0,75 - 2,5 (1,5)		0,75 - 2,5 (1,5)	
	AWG	18 - 14			18 - 14		18 - 14	

Data according to UL and cUL

Type	..69..20	..69..25	..69..32	..69..40	..69..63	..69..80	..69..100	
Rated voltage	V	600	600	600	600	600	600	
Ampere-Rating "General use"	A	20	25	32	40	63	80	100
DOL-Rating 3-phase 110-120V	HP	1	1,5	2	2	3	5	10
	HP	3	5	5	5	10	10	25
	HP	7,5	10	10	10	20	20	50
	HP	10	10	15	15	25	25	60
DOL-Rating 1-Phase 110-120V	HP	1	1	1	1	2	2	5
	HP	1	2	2	2	3	3	10
	HP	2	2	3	3	5	5	15
Fuse size (RK5) Manual Motor Controller 5kA / 600V	A	40	50	50	70	90	110	125
	A	40	50	50	50	70	70	125
Tightening torque Motor Disconnect	Nm	1,2 - 2,3	1,2 - 2,3	1,2 - 2,3	1,2 - 2,3	2,8 - 4	2,8 - 4	1,7 - 4,5
	lb.inch	11 - 20	11 - 20	11 - 20	11 - 20	24 - 35	24 - 35	15 - 40

1) Suitable for: earthed-neutral systems, overvoltage category I to III, pollution degree 3 (standard-industry); Uimp = 6kV. Data for other conditions on request

## Dimensions (mm)

### Base mount door interlock LB69..

ON-OFF Switches 3-pole, 4-pole

L = X - 40±3 for LB69..20-80  
L = X - 44±3 for LB69..100

6-pole  
for LB69..20-40  
L = X - 40±3

ON-OFF Switches 6-pole, 8-pole

L = X - 60±3

Mounting holes

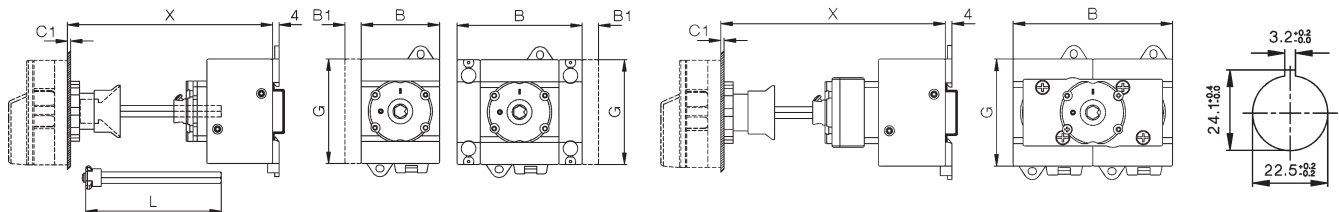

Type	3-pole		4-pole		6-pole		8-pole		aux. contact		4.Pole N		C1	D1	D2	D3	E	G	K	K1	J
	A	B	B	B	B	B	B1	B2	B1	B2											
LB69..20-40	64	48	48	77	97	10	14,5	1-5	9	5	M4	48	64	25	48	70					
LB69..63-80	64	48	62,5	97	126	10	14,5	1-5	9	5	M4	48	64	25	48	70					
LB69..100	64	78	78	-	-	10	-	1-5	9	5	ME	48	85	38	-	90					

### Base mount door interlock LB69..

ON-OFF Switches LB69..20-80

3-pole, 4-pole  
6-pole LB69..20-40

6-pole, 8-pole

LB69..100  
3-pole, 4-pole

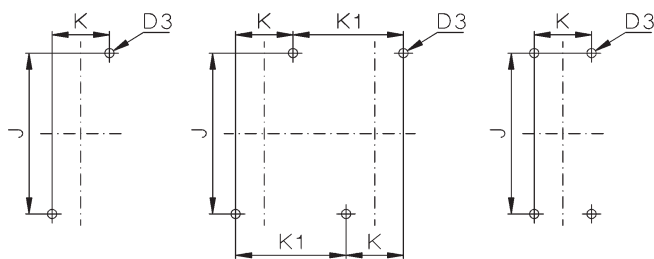

Mounting of Accessories LB69..20-80  
Base mounting, for distribution boards

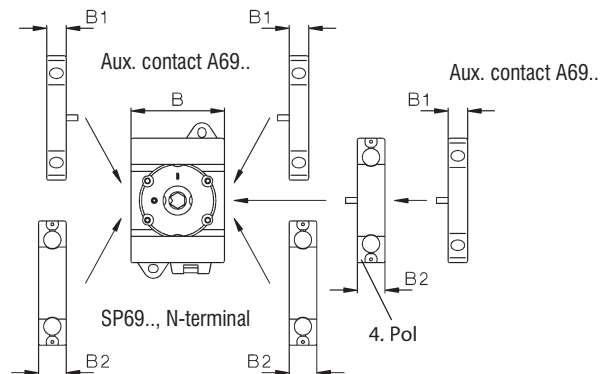

### Main Switches, Switches Disconnectors DM69..

Direct handle base mount DM69..  
ON-OFF Switches 3-pole, 4-pole

ON-OFF Switches 6-pole  
for DM69..20-40

ON-OFF Switches 6-pole, 8-pole

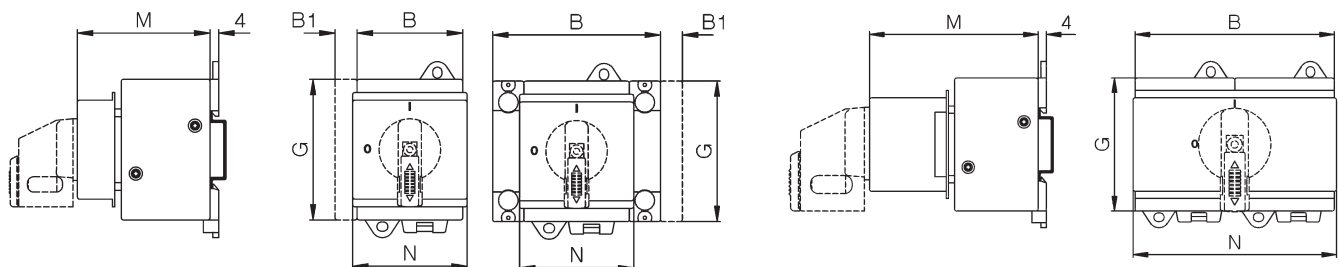

Type	padlock device	3-pole		4-pole		6-pole		8-pole		aux. contact		4.Pole N		3-pole 4-pole		6-pole 8-pole		3-pole 4-pole		6-pole 8-pole	
		B	B	B	B	B	B	B	B	B1	B2	G	M	M	M	N	N	N	N	N	
DM69..20-40	B48,RY48	48	48	77	96	10	14,5	64	60	60	74	52	52	97							
DM69..63-80	B48,RY48	48	62,5	96	125	10	14,5	64	60	74	74	52	97	126							
DM69..100	RY48	78	78	-	-	10	-	85	60	-	-	78	-	-							

## Dimensions (mm)

### IP65 Enclosed PE69

Type	Pole	A	B	C	D1	D2	E	F	H
PE69..20-40	3, 4	130	98	121	2x25,5/20,5	-	75	100	77
PE69..63-100	3, 4	200	120	-	40,5/32,5 + 16,5	-	95	165	86
PE69..20-40	6	200	120	-	40,5/32,5 + 16,5	-	95	165	86
PE69..20-40	8	240	160	-	40,5/32,5	-	130	228	120
PE69..63-80	6, 8	240	160	-	40,5/32,5	-	130	228	120

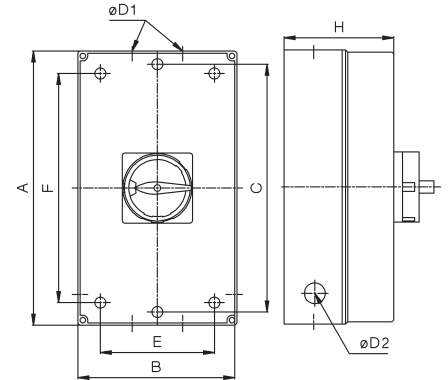

### Main Switches, Switch Disconnectors PM69..

Panel mounting PM69..

ON-OFF Switches 3-pole, 4-pole

ON-OFF Switches 6-pole, 8-pole

Mounting holes

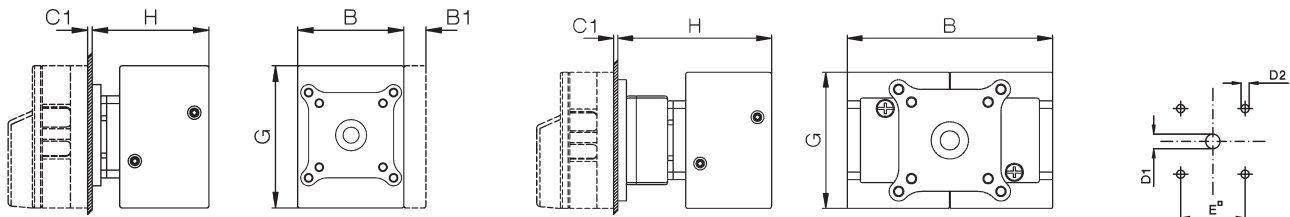

Type	ON-OFF Escutch. plate or padlock device	3-pole		4-pole	6-pole	8-pole	aux. contact	4.Pole N			D2	E	F	3-pole		6-pole	H
		A	B	B	B	B	B1	B2	C1	D1				G	H	H	
PM69..	B48, RY48	48	48	62,5	-	-	10	14,5	1-5	9	5	36	-	64	54	-	
PM69..	B64, RY64	64	48	62,5	97	126	10	14,5	1-5	9	5	48	-	64	54	74	
PM69..100	B64, RY64	64	78	78	-	-	10	14,5	1-5	9	5	48	-	85	60	-	

### Handles

H69-0001 / RY64

H69-0002 / B64

H69-0003 / RY48

H69-0004 / B48

