

Miniature High Power Relay RSE

- 10A Switching Capability
- Long Endurance (min.100,000 electrical operations)
- Industry Standard 8 or 11 Pin Round Terminals
- Different Sockets Available
- RoHS Compliant
- Outline Dimensions: 35.0 x 35.0 x 53.0mm

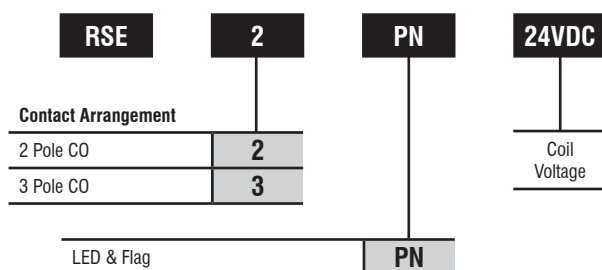

Options & Ordering Codes



Contact Data		
Contact Arrangement	2P	3P
Contact Resistance	100mΩ (at 1A 24VDC)	
Contact Material	AgSnO ₂	
Contact Rating	10A 250VAC / 28VDC	NO: 10A 250VAC / 28VDC NC: 5A 250VAC / 28VDC
Max. Switching Voltage	250VAC / 28VDC	
Max. Switching Current	10A	
Max. Switching Power	2500VA / 280W	
Mechanical Life	1x10 ⁷ OPS	
Electrical Life	1x10 ⁶ OPS	

Coil		
Coil Power	DC Type	1.5W
	AC Type	2.4VA

Coil Data at 23°C			
Nominal Voltage VDC	Pick-Up Voltage VDC	Drop-Out Voltage VDC	Coil Resistance Ω
6	4.8	0.6	23.5 (1±10%)
12	9.6	1.2	95 (1±10%)
24	19.2	2.4	430 (1±10%)
48	38.4	4.8	1630 (1±10%)
100	80.0	10.0	6800 (1±10%)
110	88.0	11.0	7300 (1±10%)

Characteristics		
Initial Insulation Resistance		500MΩ (at 500VDC)
Dielectric Strength	Between coil & contacts	1500VAC 1min
	Between open contacts	1000VAC 1min
	Between contact sets	1500VAC 1min
Operate Time (at nominal voltage)		30ms max.
Release Time (at nominal voltage)		30ms max.
Shock Resistance	Functional	98m/s ²
	Destructive	980m/s ²
Vibration Resistance		10 to 55Hz 1.5mm DA
Ambient Temperature		-40°C to +55°C
Humidity		98% RH, +40°C
Unit Weight		Approx 100g
Construction		Dust Protected

Nominal Voltage VAC	Pick-Up Voltage VAC	Drop-Out Voltage VAC	Coil Resistance Ω
6	4.8	1.8	3.9 (1±10%)
12	9.6	3.6	16.9 (1±10%)
24	19.2	7.2	70 (1±10%)
48	38.4	14.4	315 (1±10%)
110	80.0	30.0	1500 (1±10%)
220	160.0	60.0	6200 (1±10%)
230	176.0	66.0	7100 (1±10%)

Miniature High Power Relay RSE

Dimensions (mm)

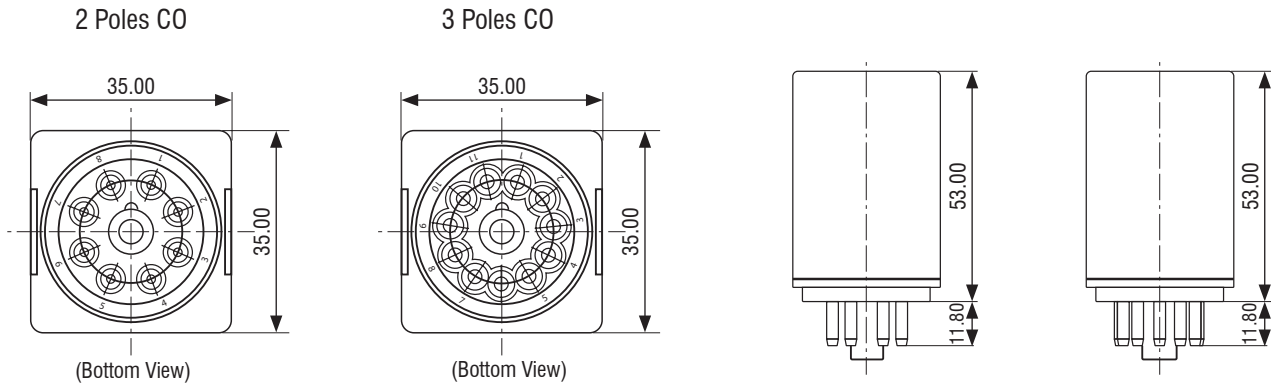

Wiring Diagram

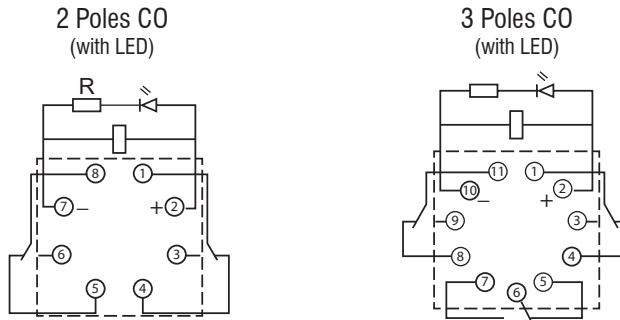

NOTE: For AC parts with diode, the positive and negative pole markings on wiring diagram are not applicable.

Bases - Dimensions (mm)



Relay	Base	Nominal Voltage (V)	Nominal Current (A)	Ambient Temperature	Dielectric Strength Min.	Screw Torque (Nm)	Wire Strip Length (mm)
RSE2	SRRE8	300V	10A	-25°C to +85°C	2500VAC	0.5Nm	7mm
RSE2	SRRE8-M	300V	10A	-25°C to +85°C	2500VAC	0.5Nm	7mm
RSE3	SRRE11	300V	10A	-25°C to +85°C	2500VAC	0.5Nm	7mm
RSE3	SRRE11-M	300V	10A	-25°C to +85°C	2500VAC	0.5Nm	7mm

SRRE8

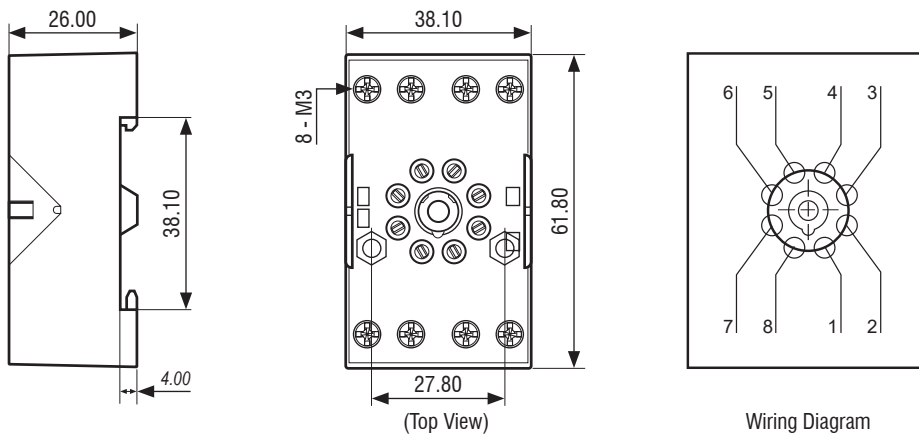

Miniature High Power Relay RSE

SRRE8-M

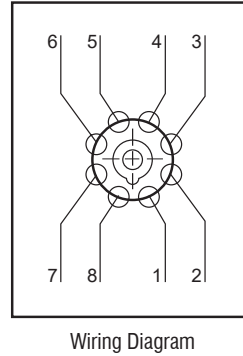
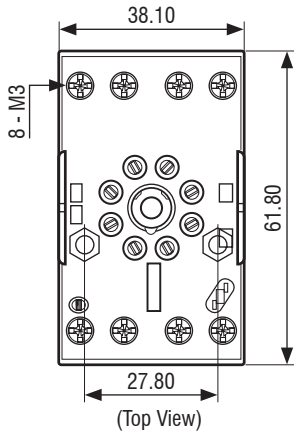
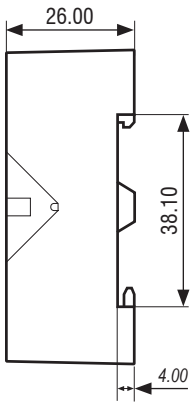

SRRE11

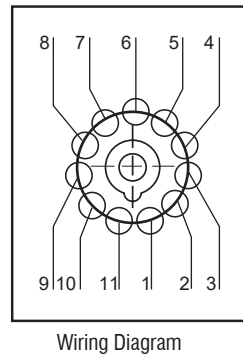
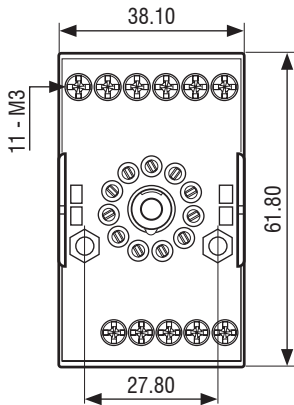
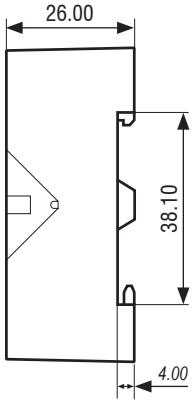

SRRE11-M

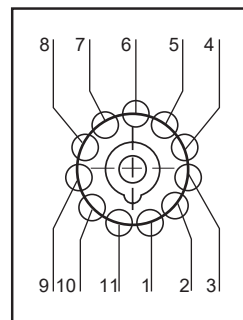
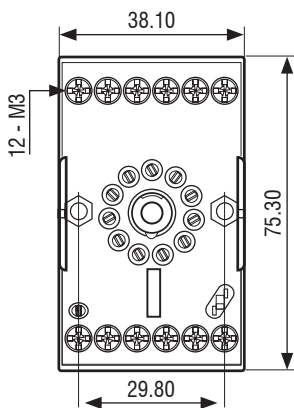
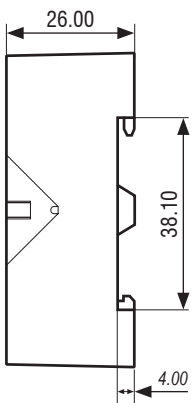

Retainer

RS-Clip

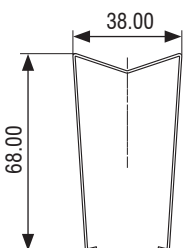

Plug-In Modules

RPDM1

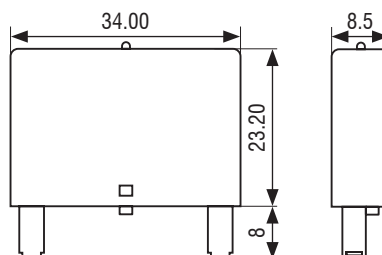

6-220VDC, Diode, -A1 to +A2

For SRR8-M, SRR11-M & Relays without LED